

**SD** SERIES

VARIABLE FREQUENCY DRIVE

Phase Converting



**SD**  
SERIES

**Phase Converting**

- Quick & easy installation and setup

**PERFECT PRESSURE™**

- Setup constant pressure in minutes
- Large backlit graphic display with intuitive menus
- Messages in clear English

**Industry Best Lead Times**

- 3-10 Business Days

**Sinewave Filter Integration**

- Minimize excessive voltage spikes
- In-house manufacturing / installation

**Superior Heat Rejection**

- Maximizing component life and uptime

**Table Of Contents**

Section	Page #
<b>SD</b> SERIES Overview	2
• Nomenclature	2
• <b>AQUAPHASE™</b> Feature Set	3
• Technical Specifications	4
• Models	5
- Optional Accessories	6
• Fuse Breaker Recommendations	7
• Line Drawings	8
• Wiring Diagram	11

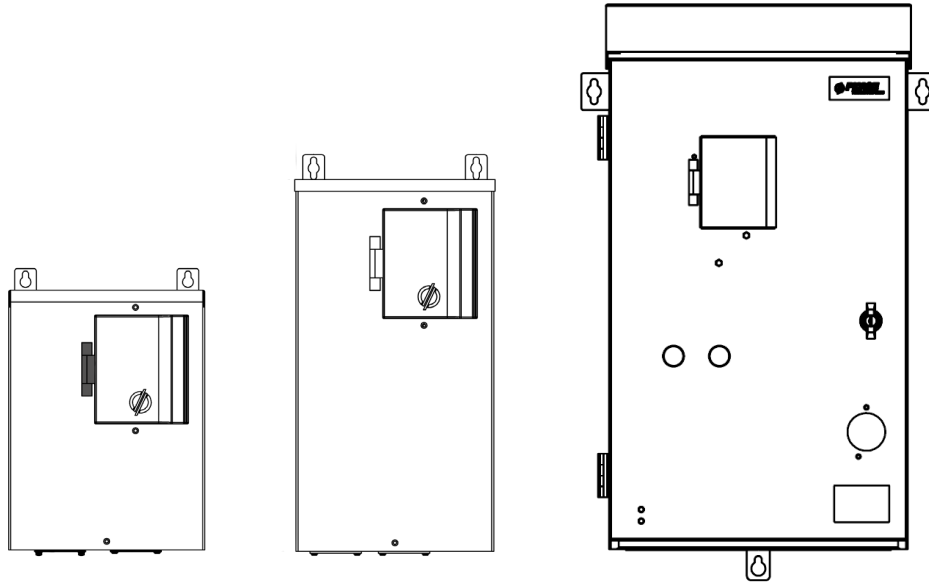

- 2 HP to 15 HP
- 240 V & 480 V Models Available
- Phase Converting
- NEMA 3R Rated Outdoor Enclosures

**Nomenclature**

Model Series	Input / Output Voltage	Rated HP	Enclosure Rating	—	OPTIONAL UL508A Panel Shop Integrator
<b>SD</b> SERIES	<b>0</b> 240V   240V Phase Converting	<b>02</b> - 2 HP <b>03</b> - 3 HP <b>05</b> - 5 HP	<b>R</b> 3R Rated Outdoor Type Rain / Bug Proof	—	Choose Option
				—	<b>H</b> - HOA Switch & Speed Pot <b>H1</b> - HOA Switch Only <b>H2</b> - Speed Pot Only

**Nomenclature**

**SDE Enterprise Series**

Example Part Number  
SDE007R-S, SDE405R-OS

Optional  
UL508A Panel Shop Integrated Options

Model Series	Input / Output Voltage	Rated HP	Enclosure Rating	Branch Circuit Protection	Output Filter	Surge Protection
<b>SDE</b> SERIES	<b>0</b> 240V   240V Phase Converting	07 - 7.5 HP 10 - 10 HP 15* - 15 HP	<b>R</b> 3R Rated Outdoor Type Rain / Bug Proof	<b>B</b> MCCB Service Disconnect	-- Not Available	<b>S</b> Strikesorb Surge Protection
	<b>4</b> 480V   480V Phase Converting	05 - 5 HP 07 - 7.5 HP 10 - 10 HP 15 - 15 HP			<b>O</b> Sinewave Filter	

**Feature Set**



**Power Behind The Pump**

AQUAPHASE™ feature set provides complete control capability for all pumping applications

Technical Specifications

Physical / Environmental	
Operating Temperature Range	-40 °C – 50 °C (-40 °F – 122 °F)
Storage Temperature Range	-40 °C – 57 °C (-40 °F – 135 °F)
Enclosure	NEMA Type 3R: Outdoor   Rainproof
Altitude	Derate by 5 °C every 2000 ft over 5500 ft of elevation
Input Power	
Input Phase	1 phase
Input Voltage	240 V   480 V
Input Voltage Range	190 V – 275 V   440 V – 520 V
Input Frequency	60 Hz
Output Power	
Output Phase	3 phase
Nominal Output Voltage	240 V   480 V
Output Voltage Range	190 V - 275 V   440 V – 520 V
Output Frequency	5 Hz – 300 Hz
Horsepower	2 HP –15 HP
Output Power	2 – 11 kW
Switching Frequency	2 kHz – 8 kHz
Output	V/f control
Integrated Output Filter	Optional Sinewave Filter on 480 V SDE models
Electrical	
Short Circuit Withstand Rating	25 kA RMS symmetrical amps (65 kA available upon request)
Efficiency	95%
Startup Ramp Time	1 – 120 s
Shutdown Ramp Time	1 – 120 s or Coast to Stop
Overload Capacity	120% for 60 s
Analog Inputs	
Quantity	(2) Programmable
Current Reference	4 – 20 mA, (2) Inputs
Voltage Reference	0 – 5 VDC, (1) Input
Terminal Block Size	26 - 12 AWG
Digital Inputs	
Quantity	(2) Programmable
Ratings	< 5 V, galvanically isolated
Terminal Block Size	26 - 12 AWG
Relay Outputs	
Quantity	(2) Programmable
Rating	Relay 1: 5 VDC, 7 A at 250 VAC Relay 2 : 5 VDC, 7 A at 250 VAC
Terminal Block Size	26 - 12 AWG
Features	
Certification	ETL listed to UL 61800-5-1 and CSA C22.2 No. 274-17
User Interface	Push button membrane keypad with backlit graphic display
Available Feature Sets	AquaPhase™ (pump control)

**Models**

Part Number	HP	Rated Input Current	Rated Output Current 208 V   240 V	Dimensions (H x W x D)	Weight
<b>SD- 208 V/240 V Input</b> Single-Phase   <b>240 V Output</b> Three-Phase					
<b>SD002R</b>	2 HP	20 A	7 A   8 A	13 x 9 x 5 in.	8.7 lbs
<b>SD003R</b>	3 HP	30 A	8 A   10 A	13 x 9 x 5 in.	8.7 lbs
<b>SD005R</b>	5 HP	42 A	15 A   18 A	17 x 9 x 5 in.	12.5 lbs

Part Number	HP	Rated Input Current	Rated Output Current 208 V   240 V	Dimensions (H x W x D)	Weight
<b>SDE- 208 V/240 V Input</b> Single-Phase   <b>240 V Output</b> Three-Phase					
<b>SDE007R</b>	7.5 HP	58 A	23 A   27 A	31 x 19 x 19 in.	95 lbs
<b>SDE010R</b>	10 HP	69 A	28 A   33 A	31 x 19 x 19 in.	110 lbs
<b>SDE015R</b>	15 HP	92 A	40 A   46 A	31 x 19 x 19 in.	120 lbs

Part Number	HP	Rated Input Current	Rated Output Current 480 V	Dimensions (H x W x D)	Weight
<b>SDE - ENTERPRISE - 480 V Input</b> Single-Phase   <b>480 V Output</b> Three-Phase					
<b>SDE405R</b>	5 HP	30 A	10 A	31 x 19 x 19 in.	95 lbs
<b>SDE407R</b>	7.5 HP	37 A	13 A	31 x 19 x 19 in.	100 lbs
<b>SDE410R</b>	10 HP	42 A	18 A	36 x 21 x 18 in.	110 lbs
<b>SDE415R</b>	15 HP	56 A	25 A	36 x 21 x 18 in.	120 lbs

**Optional Integrations & Accessories**

Part Number	Description	Standard User Installation	Optional UL508A Panel Shop Installation (Additional Fee Applies)
<b>Kits</b>			
*Below kits only available on SD models with MCCB Service Disconnect			
*KIT E - H	HOA Switch & Speed Potentiometer	Yes	Yes
*KIT E - H1	HOA Switch Only	Yes	Yes
*KIT E - H2	Speed Potentiometer Only	Yes	Yes
*KIT E, S 240V 3P	Strikesorb Surge Protection, 240 V, Single-Phase	Yes	Yes
*KIT E, S 480V 3P	Strikesorb Surge Protection, 480 V, Single-Phase	Yes	Yes
*KIT E, S1 240V 3P	Protec Surge Protection	Yes	Yes
*KIT E, S1 480V 3P	Protec Surge Protection	Yes	Yes
<b>Transducer</b>			
S00150	0-150 psi Transducer with 15ft lead	Yes	No
S00150-25	0-150 psi Transducer with 25ft lead	Yes	No
S00150-50	0-150 psi Transducer with 50ft lead	Yes	No
S00150-100	0-150 psi Transducer with 100ft lead	Yes	No
<b>Other Parts</b>			
PSI SNUB	Pressure Snubber for Transducers	Yes	No
CVR0002	Keypad Locking Security Cover for <b>SD</b> SERIES models with MCCB Service Disconnect option added	Yes	No
CVR001	HOA Switch and Speed Pot Security Cover	Yes	No
LF0018	GPS Output Filter	Yes	No
<b>Miscellaneous</b>			
[Custom]	Run or Fault Indicator Light and 150VA Power Supply	No	Yes
[Custom]	Additional Run or Fault Indicator Light	No	Yes

**Recommended Fuse & Breaker Ratings**

Model Number	Horsepower	VFD	
		Recommended Fuse Rating Class J	Recommended Circuit Breaker Rating
<b>SD &amp; SDE - 208 V/240 V Single-Phase   240 V Output Three-Phase</b>			
SD002R	2 HP	25 A, 600 V	25 A
SD003R	3 HP	40 A, 600 V	40 A
SD005R	5 HP	55 A, 600 V	55 A
SDE007R	7.5 HP	80 A, 600 V	80 A
SDE010R	10 HP	100 A, 600 V	100 A
SDE015R	15 HP	120 A, 600 V	120 A
<b>SDE - ENTERPRISE - 480 V Input Three-Phase   480 V Output Three-Phase</b>			
SDE405R	5 HP	40 A, 600 V	40 A
SDE407R	7.5 HP	60 A, 600 V	60 A
SDE410R	10 HP	60 A, 600 V	60 A
SDE415R	15 HP	80 A, 600 V	80 A

**Line Drawings**



**SD**  
SERIES

Model Number
SD002R
SD003R

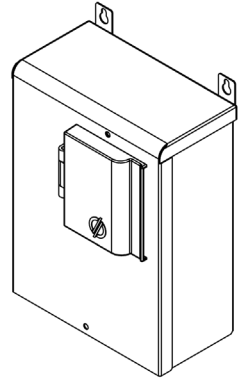
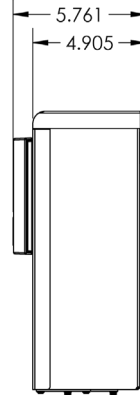
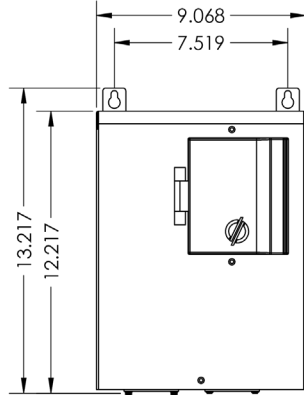

**SD**  
SERIES

Model Number
SD005R

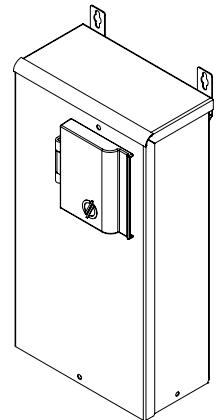
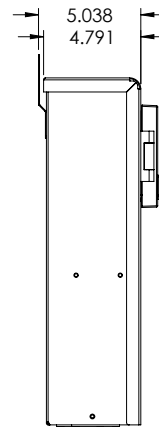
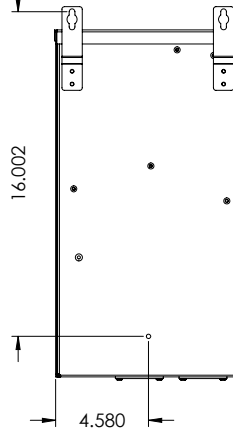
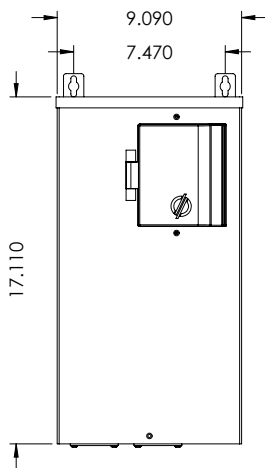



Line Drawings



**SDE**  
SERIES

Model Number
SDE007R
SDE010R
SDE015R
SDE405R
SDE407R

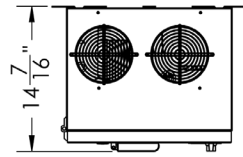

TOP

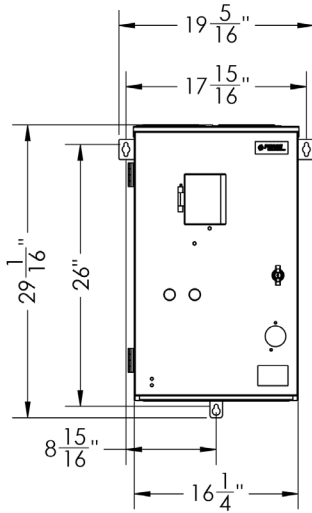

FRONT

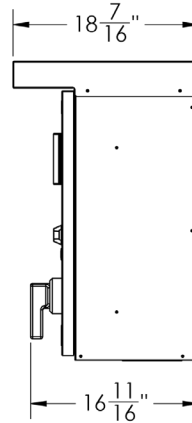

SIDE - 3R AND BREAKER

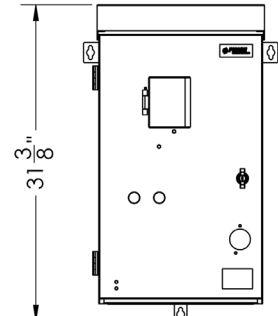

FRONT - 3R AND BREAKER



**SDE**  
SERIES

Model Number
SDE410R
SDE415R

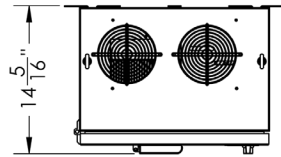

TOP

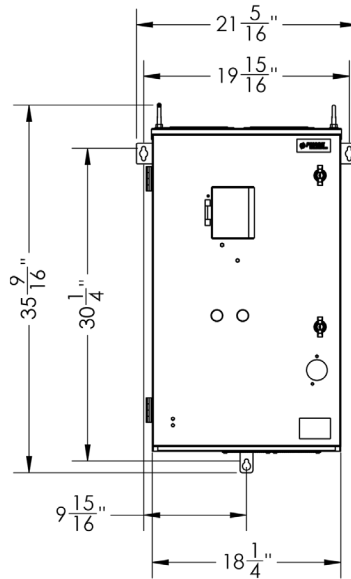

FRONT

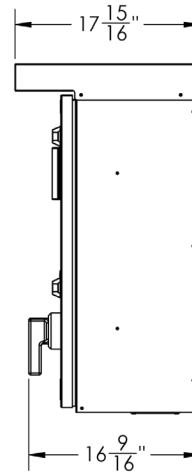

SIDE - 3R AND BREAKER

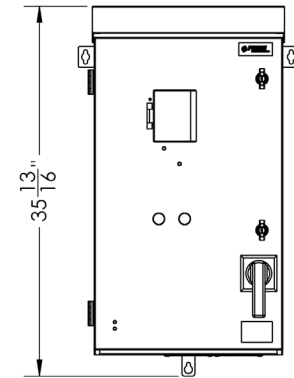

FRONT - 3R AND BREAKER

Wiring Diagram

**SD** SERIES *Wiring Diagram*

