

User Manual

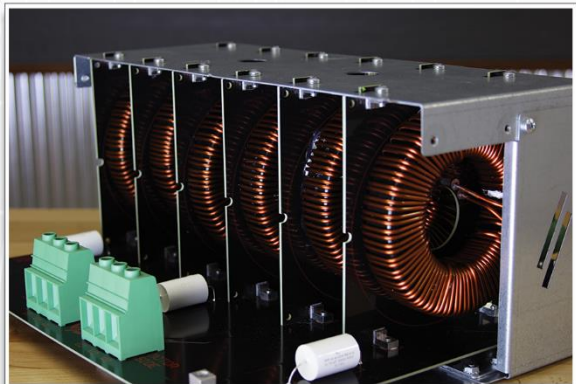

DV SERIES SW SERIES OUTPUT FILTERS

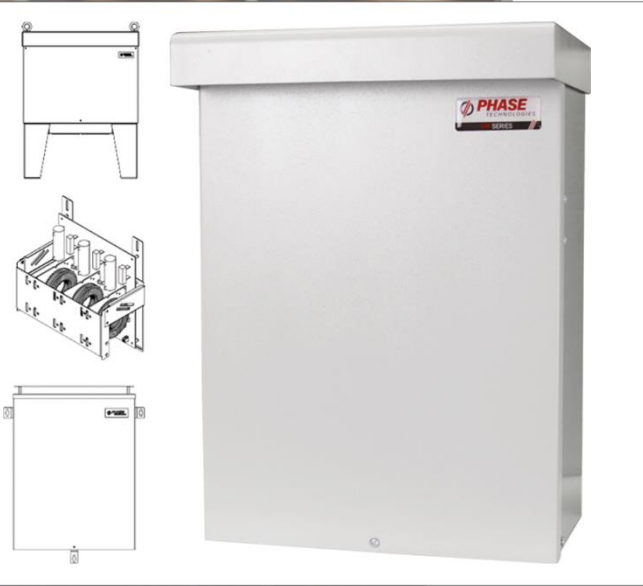

DV
SERIES
SW
SERIES
OUTPUT
FILTERS



222 Disk Drive
Rapid City, SD 57701

Phone: 605-343-7934
Fax: 605-343-7943
Toll Free: 866-250-7934

www.phasetechnologies.com



2022 © Copyright.V1.1 All rights reserved. All contents are property of Phase Technologies, LLC.

No portion of this publication or its contents may be duplicated by any means, electronic or otherwise, without the express written consent of Phase Technologies, LLC.

V0.0_09012022

SAFETY MESSAGES AND WARNINGS

To ensure safe and reliable operation of output filters, it is important to carefully read this manual and to observe all warning labels attached to the unit before installing. Please follow all instructions exactly and keep this manual with the unit for quick and easy reference.

Definitions of Warning Signs and Symbols

 **CAUTION:** Indicates a potentially hazardous situation that could result in injury or damage to the product.

 **WARNING:** Indicates a potentially hazardous situation that could result in serious injury or death.

 **HIGH VOLTAGE:** The voltage associated with the procedures referenced could result in serious injury or death. Use caution and follow instructions carefully.

**READ THESE WARNINGS BEFORE INSTALLING
OR OPERATING EQUIPMENT!**

 **WARNING:** Risk of electric shock. More than one disconnect switch may be required to de-energize the equipment before servicing.

 **WARNING:** Risk of electric shock. Before servicing the equipment, de-energize the filter by disconnecting all incoming sources of power, wait 10 minutes for internal charges to dissipate, and verify with a voltmeter that all power sources are off and capacitors are discharged. Failure to do so may result in severe injury or death.

 **HIGH VOLTAGE:** This equipment is connected to line voltages that can create a potentially hazardous situation. Electric shock could result in serious injury or death. This device should be installed only by trained, licensed, and qualified personnel. Follow instructions carefully and observe all warnings.

 **WARNING:** This equipment should be installed and serviced by qualified personnel familiar with the type of equipment and experienced in working with dangerous voltages.

 **WARNING:** Installation of this equipment must comply with the National Electrical Code (NEC) and all applicable local codes. Failure to observe and comply with these codes could result in risk of electric shock, fire, or damage to the equipment.

 **CAUTION:** Circuit breakers, fuses, proper ground circuits, and other safety equipment and their proper installation are not provided by Phase Technologies, LLC, and are the responsibility of the end user.

 **CAUTION:** Failure to maintain adequate clearance may lead to overheating of the unit and cause damage or fire.

 **WARNING:** Input power connections should be made by a qualified electrician into circuit with adequate voltage and current carrying capacity for the model.

 **CAUTION:** Use 600 V vinyl-sheathed wire or equivalent. The voltage drop of the leads needs to be considered in determining wire size. Voltage drop is dependent on wire length and gauge. Use only copper conductors.

 **CAUTION:** Wires fastened to the terminal blocks shall be secured by tightening the terminal screws to a torque value listed in **Table 4**.

 **CAUTION:** The maximum wire gauge for the input terminals is listed in **Table 4**.

 **CAUTION:** Never allow bare wire to contact metal surfaces.

 **CAUTION:** For SW filters with internally powered fans, ensure that the variable frequency drive (VFD) is set to V/f (Volts per Hz) mode. Failure to properly configure the VFD could result in failure of the VFD or filter components.

 **CAUTION:** Before installation, visually inspect the filter and secure any loose electrical connections before applying power. Failure to do so may result in damage to the filter or diminished performance.

TABLE OF CONTENTS

1 INTRODUCTION	1
1.1 RECEIVING INSTRUCTIONS	2
1.2 NOMENCLATURE	3
1.3 MODELS AND RATINGS	3
2 RATINGS	4
2.1 PRODUCT SPECIFICATIONS	4
3 INSTALLATION	6
3.1 MOUNTING YOUR NEW OUTPUT FILTER	6
3.2 PROPER VENTILATION	6
3.3 GROUNDING	6
3.4 GROUND FAULT PROTECTION	6
3.5 OVERTEMPERATURE SWITCH	6
3.6 INSTALLING POWER WIRING	7
3.7 STARTUP CHECKLIST.....	11
3.8 EVALUATING OUTPUT FILTER PERFORMANCE.....	11
4 TROUBLESHOOTING	13
4.1 ROUTINE INSPECTION AND MAINTENANCE	13
4.2 FIELD TROUBLESHOOTING	13
5 PRODUCT DIMENSIONS	15
6 NOTES	21
7 WARRANTY	22

1 INTRODUCTION

Output filters are used to remove unwanted high frequency content from the output of a Variable Frequency Drive (VFD). Large voltage spikes are produced when VFDs are used to drive motors with long cable leads, which can damage motor or cable insulation systems or motor bearing fluting due to electric discharge. This voltage spike is known as the Reflected Wave Phenomenon. dV/dt filters extend motor and cable life by reducing the effects of the Reflected Wave Phenomenon and reducing peak voltage. dV/dt filters should be used when motor cables are between 50 and 1,000 feet.

For additional protection on cables leads longer than 1,000 feet, sine wave filters provide more robust removal of higher frequency content. As well as providing protection against voltage spikes from reflected waves, a sine wave filter removes lower order harmonic voltage and currents. These benefits are realized in reduced motor losses (less heating) due to lower eddy currents and magnetic hysteresis losses in motor steel laminations.

Figure 1 shows an unfiltered VFD output voltage measured line-to-line.

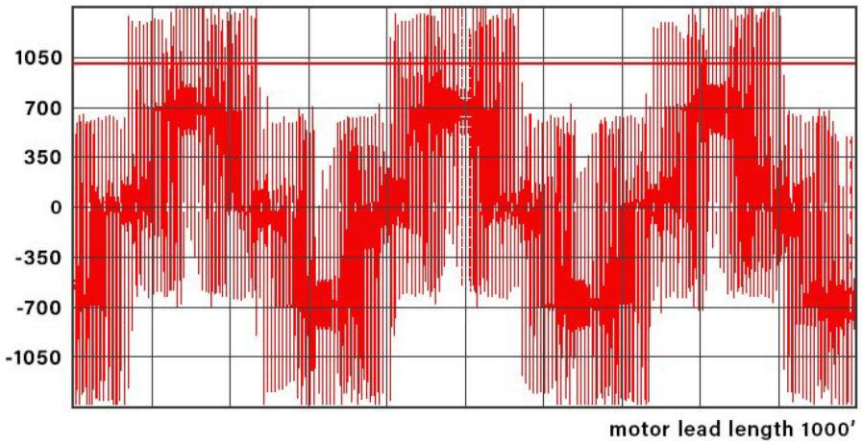

Figure 1 – Unfiltered VFD Output Voltage

Figure 2 shows output voltage after being filtered by the DV Series dV/dt filter.

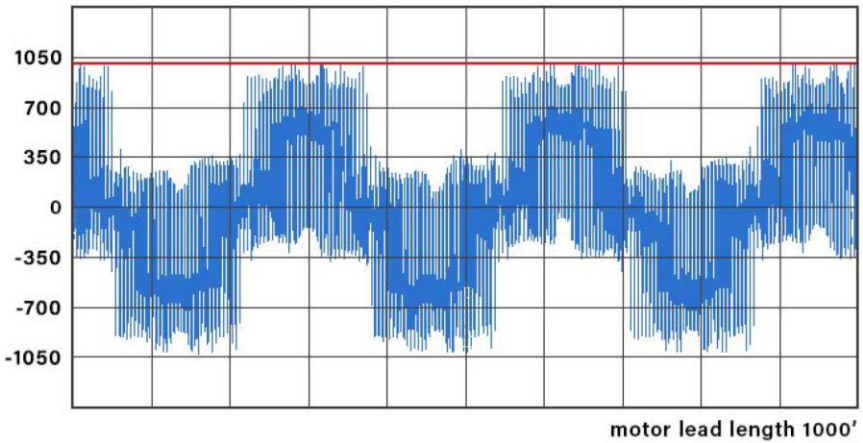

Figure 2 – Output Voltage After DV Series dV/dt filter.

Figure 3 shows output voltage after being filtered by the SW Series sine wave filter.

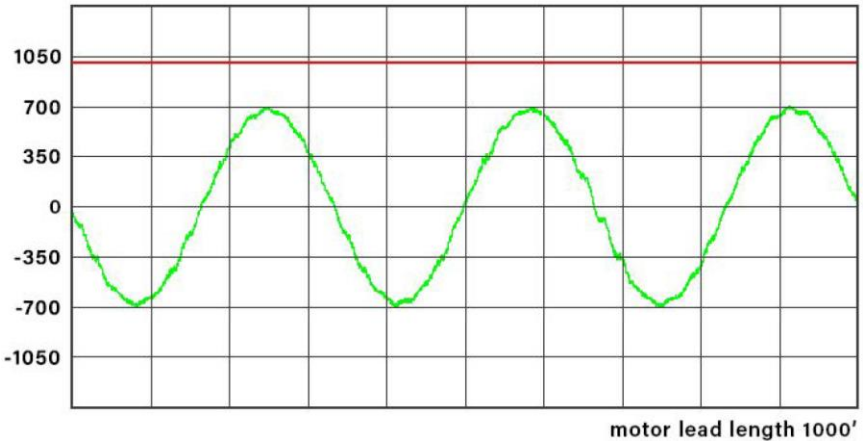

Figure 3 – Output Voltage After sw Series Sine Wave Filter.

Phase Technologies output filters can be configured in Open, NEMA Type 1, or NEMA Type 3R enclosures. Open filters are intended to be installed in a panel. Type 1 filters come with an enclosure designed for indoor use only. Type 3R enclosures are made for outdoor use. Make sure the filter has the proper enclosure type for your application.

1.1 Receiving Instructions

Phase Technologies sine wave filters are thoroughly inspected and tested before packaging for shipment. Upon receiving the unit, immediately inspect it for any damage that may have occurred during shipping. If any damage is found, contact the Phase

Technologies' service department at (605) 343-7934. Loose electrical connections can also cause damage to the filter or diminish its performance. Visually inspect the filter and tighten any loose connections found.

1.2 Nomenclature

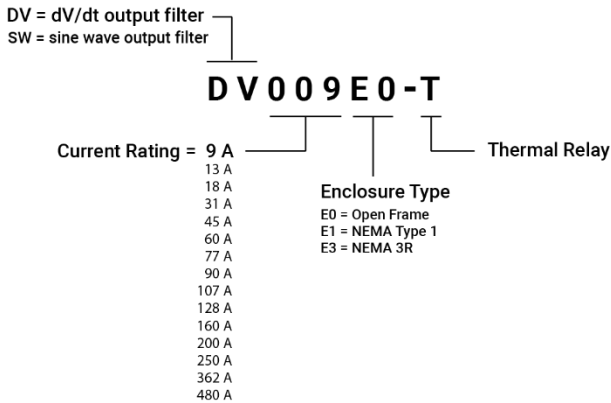

1.3 Models and Ratings

Table 1 – Output Filter Ratings

DV Series dV/dt Filters		
Model	HP	Rated Current (A)
DV009E	5	9
DV013E	7.5	13
DV018E	10	18
DV031E	20	31
DV045E	30	45
DV060E	40	60
DV077E	50	77
DV090E	60	90
DV107E	75	107
DV128E	100	128
DV160E	125	160
DV200E	150	200
DV250E	200	250
DV362E	300	362
DV480E	400	480

SW Series Sine Wave Filters		
Model	HP	Rated Current (A)
SW009E	5	9
SW013E	7.5	13
SW018E	10	18
SW031E	20	31
SW045E	30	45
SW060E	40	60
SW077E	50	77
SW090E	60	90
SW107E	75	107
SW128E	100	128
SW160E	125	160
SW200E	150	200
SW250E	200	250
SW362E	300	362
SW480E	400	480

2 RATINGS

2.1 Product Specifications

Table 2 – General Specifications, DV Series Filters

	DV Series dV/dt Filter
Input Voltage Waveform	PWM
VFD Output Voltage	≤ 600 VAC, 3-phase*
VFD Output Frequency	≤ 500 Hz
VFD Switching Frequency	2 kHz – 10 kHz**
Current Range	9 – 480 A
Maximum Motor Lead Length	1,000 feet
Max Peak Voltage	150% of DC bus voltage up to 1,000 feet
Max dV/dt at Motor	≤ 200V/μs
Insertion Loss (Voltage)	≤ 1% at 60Hz ≤ 1.5% at 90Hz
Efficiency	≥ 99%
Enclosure Options	Open, NEMA 1, or NEMA 3R
Operating Temperature	-20 °C to 40 °C (-4 °F to 104 °F)
Storage Temperature	-25 °C – 74 °C (-13 °F – 165 °F)
Maximum Humidity	95%, non-condensing
Elevation	Derate by 5 °C for every 2,000 feet over 5,500 feet of elevation

* SW Series filters above 90 A are only rated for 480 VAC, 3-phase but have an optional 600 V model.

DV Series filters are optimized for 4 kHz switching frequency. If operating **above 4 kHz, requires current derate.

Table 3 – General Specifications, SW Series Filters

	SW Series Sine Wave Filter
Input Voltage Waveform	PWM
VFD Output Mode	Volts per Hertz*
VFD Output Voltage	≤ 480 VAC, 3-phase
VFD Output Frequency	≤ 90 Hz
VFD Switching Frequency	≥ 4.0kHz: SW009-SW107** ≥ 3.0kHz: SW128-SW250** ≥ 2.5kHz: SW362-SW480**
Current Range	9 – 480 A
Insertion Loss (Voltage)	≤ 3.8% at 60 Hz ≤ 5.7% at 90 Hz
Efficiency	≥ 98%
Enclosure Options	Open, NEMA 1, or NEMA 3R
Operating Temperature	-20 °C to 40 °C (-4 °F to 104 °F)
Storage Temperature	-25 °C – 74 °C (-13 °F – 165 °F)
Maximum Humidity	95%, non-condensing
Elevation	Derate by 5 °C for every 2,000 feet over 5,500 feet of elevation

*SW200, SW250, SW362, SW480 models

**SW Series filters are optimized for the minimum listed switching frequency. Current derate is required if operating lower.

3 INSTALLATION

3.1 Mounting Your New Output Filter

Proper installation of the unit is important to the performance and normal operating life. It should be installed in a location free from:

- Corrosive gases or liquids
- Excessive vibration
- Airborne metallic particles

Open type filters should be installed in a panel by a qualified UL 508A panel shop. If wall-mounted, mount the unit to a solid, non-flammable surface capable of bearing the weight using the mounting brackets provided with the unit. Floor mounted filters should be attached to the legs provided and fastened to the floor using concrete anchors or similar.

3.2 Proper Ventilation

To maintain air circulation for adequate cooling, minimum clearance around the unit must be maintained. Allow six inches on each side and top, and 18 inches below.

Ensure openings are not obstructed. If the unit is mounted in a small room, cabinet, or building, ensure there is adequate ventilation to provide sufficient cooling for the unit.

3.3 Grounding

- Properly ground the filter according to local electrical code.
- Connect the ground lug to the branch circuit or service ground conductor.
- Resistance to ground measurement must be **25 Ohms or less**, according to the National Electric Code.

3.4 Ground Fault Protection

Devices that utilize power switching electronics like variable frequency drives, emit high leakage current so ground fault protection devices may not be compatible with a VFD and output filter.

3.5 Overtemperature Switch

Phase Technologies output filters have an optional self-resetting overtemperature circuit with a Normally Closed relay that will open when an internal temperature of 180 °C (± 5 °C) is reached. An overtemperature relay is highly recommended to shut down the VFD if the filter temperature reaches an unsafe level. This prevents damage to the filter in rare cases when components overheat due to abnormal operating conditions. If using a Phase Technologies VFD, the overtemperature relay should be connected to one of the Auxiliary terminals and the setting AUX SELECT should be set to CLOSED = RUN, OPEN = STOP.

Table 4 – Overtemperature Switch

Normally Closed (NC) Thermal Switch: 180 °C open, +/-5°C	
Voltage	Current
250 VAC	8 A

3.6 Installing Power Wiring

WARNING: Connecting wires improperly will void warranty and may damage filter.

WARNING: Input and output wiring to the filter should be performed by authorized personnel in accordance with the NEC and all local electrical codes and regulations.

CAUTION: Use 600 V wire that is appropriately rated for the current rating of the motor. Use copper wire with an insulation temperature rating of 75°C or higher. Installations must comply with all local regulations and the National Electrical Code (NEC).

Verify that the power source is appropriate for the filter being used. Connect the VFD output (T1, T2, T3 or U, V, W) to the input of the filter (**U1, V1, W1**). Connect the motor to the output terminals of the filter (**U2, V2, W2**). A fused disconnect or circuit breaker should be installed between the VFD and its power source in accordance with NEC requirements. See **Figure 4** for a system schematic.

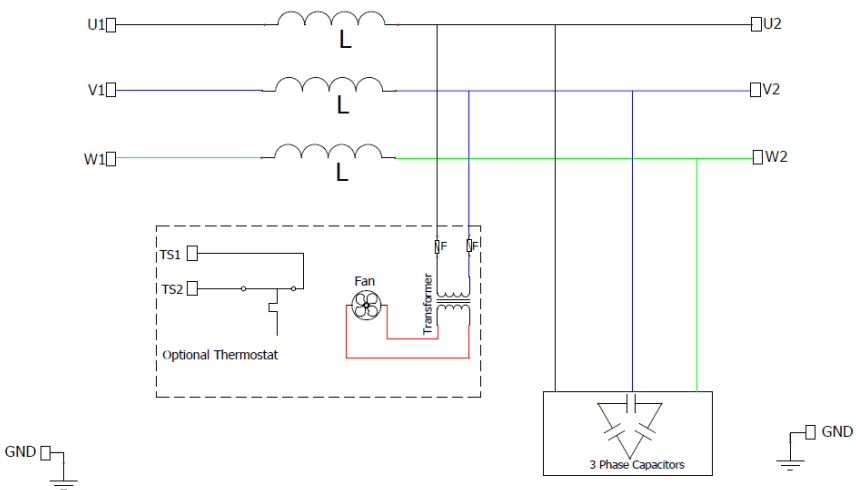

Figure 4 – Filter System Schematic

CAUTION: Continuous metal conduit should be used on all power cables, both VFD and motor side, to reduce conducted and emitted radiation of electromagnetic interference (EMI). The conduit must be securely grounded to the enclosure of the VFD and the motor case.

Power cables should enter only through the bottom of the enclosure in the supplied conduit openings. If any conduit holes remain unused, they must be covered with a 3R hole plug to maintain the NEMA 3R rating. Do not install VFD side cables in the same conduit or cable tray with motor power cables. See **Figure 5 - Figure 7** for conduit opening dimensions.

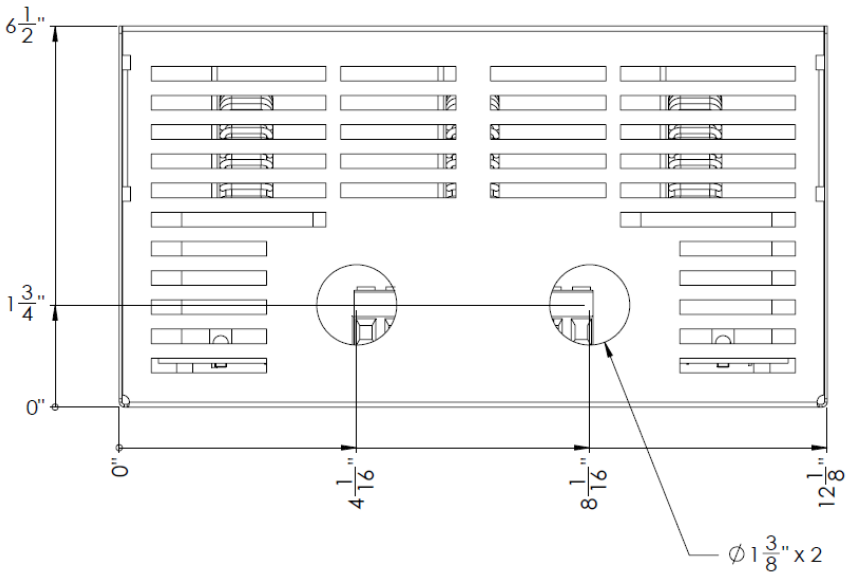

Figure 5 – Conduit Hub Locations, Enclosure A

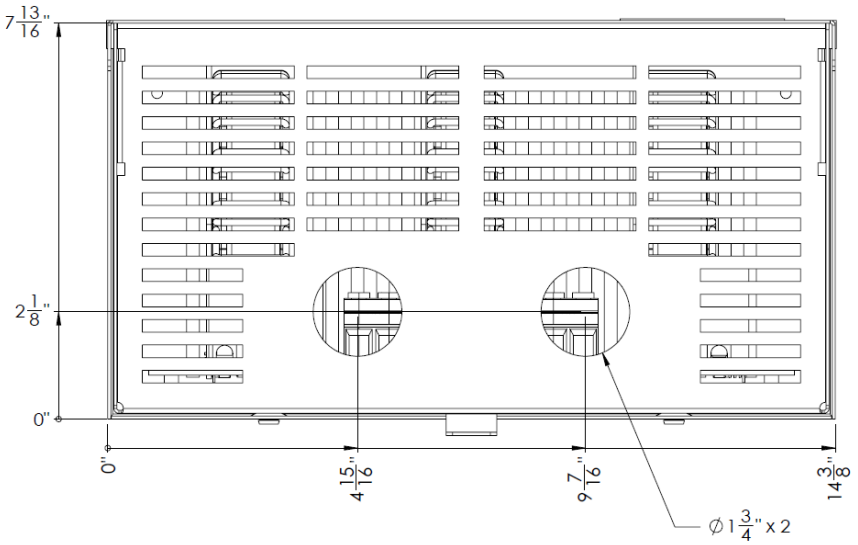

Figure 6 – Conduit Hub Locations, Enclosure B

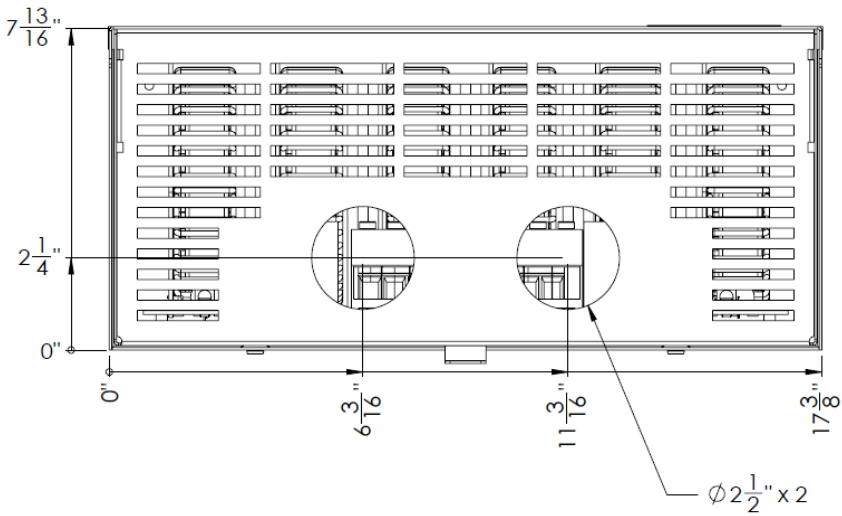

Figure 7 – Conduit Hub Locations, Enclosure C

VFD cables should be installed in the terminal block labeled U1, V1, and W1 and motor cables should be installed in the terminal block labeled U2, V2, W2. Field wiring terminal block locations can be seen in **Figure 8** and **Figure 9**.

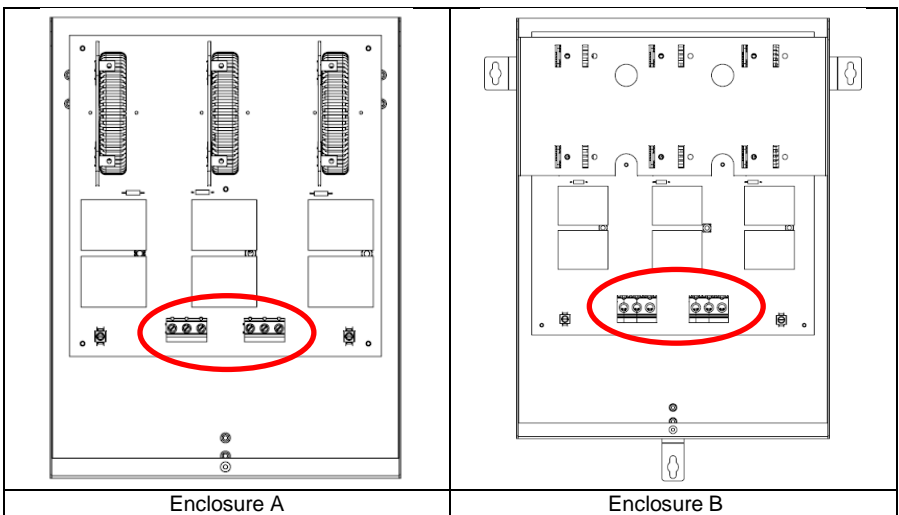

Figure 8 – Field Wiring Terminals, Enclosure A and B

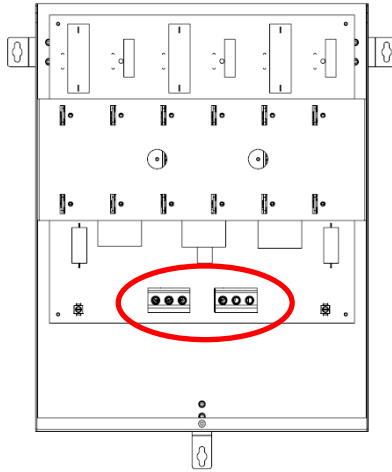

Figure 9 – Field Wiring Terminals, Enclosure C

Table 4 – Power Terminal Specifications and Field Wiring Tools

Models		Wire Size	Torque	Tool
DV009 DV013 DV018 DV031 DV045	SW009 SW013 SW018	26 – 6 AWG	10.5 in-lbs	PH2 Phillips
DV060 DV077	SW031 SW045	20 – 2 AWG	17.5 in-lbs	PH2 Phillips
DV090 DV107 DV128	SW060 SW077	16 – 2/0 AWG	48 in-lbs	T30 Torx
	SW090 SW107 SW128	14 – 10 AWG 8 AWG 6 – 4 AWG 3 – 2/0 AWG	35 in-lbs 40 in-lbs 45 in-lbs 50 in-lbs	1/4" Hex
DV160	SW160	6 – 2 AWG 1 AWG – 250 kcmil	275 in-lbs 375 in-lbs	3/8" Hex
DV200 DV250 DV362	SW200 SW250 SW362	6 AWG – 350 kcmil	375 in-lbs	3/8" Hex
DV480	SW480	4 AWG – 600 kcmil	500 in-lbs	1/2" Hex

3.7 Startup Checklist

Prior to operation, verify the following:

1. The filter is securely attached to the proper mounting surface
2. All filter ground terminals are properly bonded to earth ground
3. The filter input terminals are connected to the *output* of a VFD and the VFD is set properly*:
 - o Output frequency is less than 90 Hz
 - o PWM Switching Frequency is 2 – 8 kHz
 - o Operation mode is Volts per Hertz without DC braking
4. An appropriately rated motor is connected to the filter output terminals
5. The motor is secured and properly mounted

Note: VFD motor auto-tuning procedures will be greatly affected and likely will result in inaccurate results. Consult with VFD supplier if auto-tuning is desired with filter installed.

3.8 Evaluating Output Filter Performance

Output filter performance can be evaluated by viewing the output voltage wave form with an oscilloscope. **Figure 10** shows a typical VFD output voltage waveform when measured line-to-line.

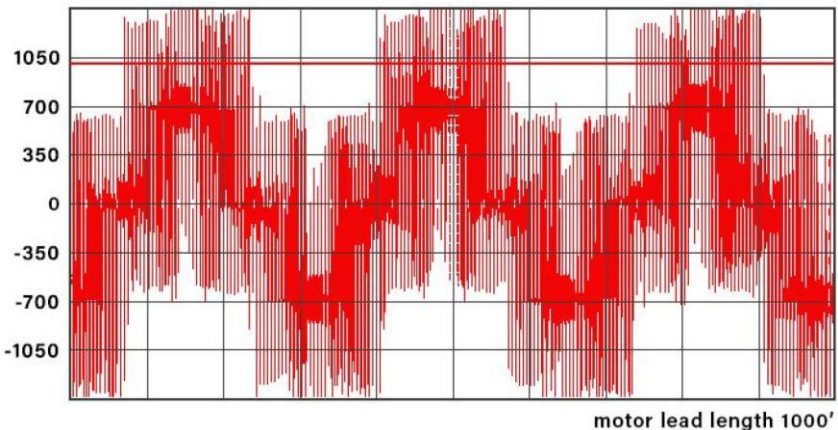

Figure 10 – VFD Line-to-Line Output Voltage

Figure 11 shows a typical dV/dt filter output voltage measured line-to-line with an oscilloscope. Note that peak voltages are reduced compared to a standard VFD output.

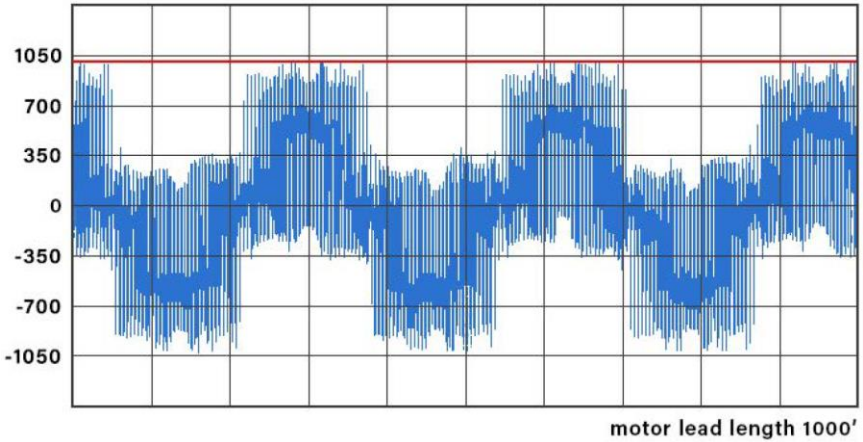

Figure 11 – dV/dt Filter Line-to-Line Output Voltage

Figure 12 shows a typical sine wave filter output voltage measured line-to-line with an oscilloscope. The PWM wave form has been filtered into a true sine wave.

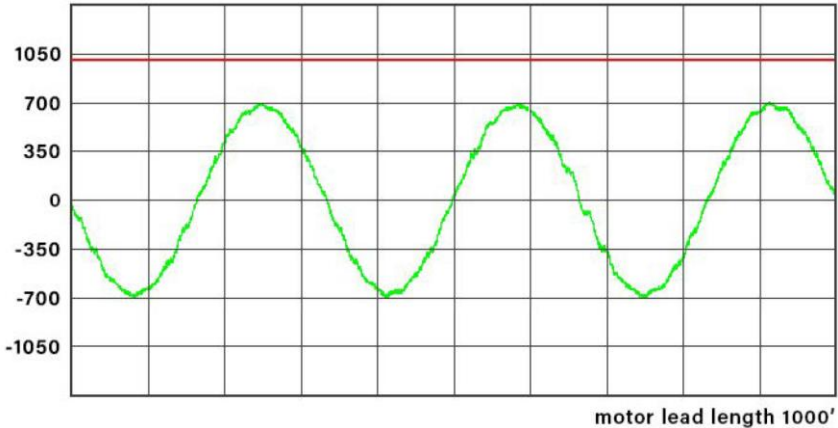

Figure 12 – Sine Filter Output Line-to-Line Voltage

If the filter output waveform looks closer to a typical VFD output waveform instead of sinusoidal like **Figure 12**, troubleshoot the filter wiring and components.

4 TROUBLESHOOTING

This section provides information on routine inspections and troubleshooting tips for potential system problems.



WARNING: Risk of electric shock. De-energize the unit by disconnecting all incoming sources of power, then wait 5 minutes for internal charges to dissipate before servicing the equipment.



HIGH VOLTAGE: This equipment is connected to dangerous voltages. Electric shock could result in serious injury or death. This device should be installed and serviced only by trained, licensed, and qualified personnel. Follow instructions carefully and observe all warnings.

4.1 Routine Inspection and Maintenance

The unit should be inspected and cleaned at least annually or more frequently if it is in an excessively warm or dusty environment. Annual inspections should include the following:

- Ensure that the installation environment is free of excessive dirt or contaminants
- Check that all enclosure openings are unobstructed
- Visually inspect the interior of the enclosure for signs of excessive heat or arcing on components and wires
- Verify that all ground connections are tight
- Retorque VFD and motor connections

4.2 Field Troubleshooting

To determine if the filter is working properly, you will need a multimeter capable of measuring resistance (Ω - Ohms).

1. First, visually inspect the filter for any components that may have overheated or have been physically damaged.
2. Measure continuity or resistance through the filter. The following values should be short, or less than 3 Ω :
 - a. U1 to U2
 - b. V1 to V2
 - c. W1 to W2
3. Measure continuity or resistance across the input lines. Values should be open, or greater than 100 k Ω :
 - a. U1 to V1
 - b. U1 to W1
 - c. V1 to W1
4. Measure all terminals to ground, or the metal enclosure. Values should be open, or greater than 100 k Ω :
 - a. U1 to ground
 - b. U2 to ground
 - c. U3 to ground

If your filter is equipped with the optional thermal overload switch, measure from TS1 to TS2. This should be closed (less than 3 Ω) at room temperature. If the values measured in the steps above measure correctly, use

Table 5 to walk through additional troubleshooting steps.

Table 5 – Troubleshooting Guide

PROBLEM	POTENTIAL CAUSE	SOLUTION
Motor Will Not Turn	No power	Check breakers and fuses and verify incoming voltage.
	Incorrect Wiring	Verify VFD and motor are properly connected to the filter.
	VFD Fault	Consult VFD User's Manual.
VFD Overcurrent Fault	Incorrect wiring	Verify that all VFD and motor cables are connected properly.
	Cable insulation compromised	Check wire connections. Use Megger to check for ground faults.
	Motor damage	Check motor winding resistance and use Megger to check for ground faults.
	System compatibility	Verify that current ratings of VFD, output filter, and motor are properly sized.
	VFD parameters	Consult VFD user's manual to configure proper parameters.
Temperature Switch Open	Filter Overheating	Ensure filter openings are clear and that ambient temperature is below 40 °C.
	Incompatible motor	Verify current ratings of VFD, output filter, and motor are properly sized.
	Switching Frequency is less than 2 kHz	Verify that the VFD Switching Frequency (or Carrier Frequency) is 2 kHz or higher.
Excessive Filter Noise	Incompatible motor	Verify current ratings of VFD, output filter, and motor are properly sized.
	Switching Frequency is less than 2 kHz	Verify that the VFD Switching Frequency (or Carrier Frequency) is 2 kHz or higher.

5 PRODUCT DIMENSIONS

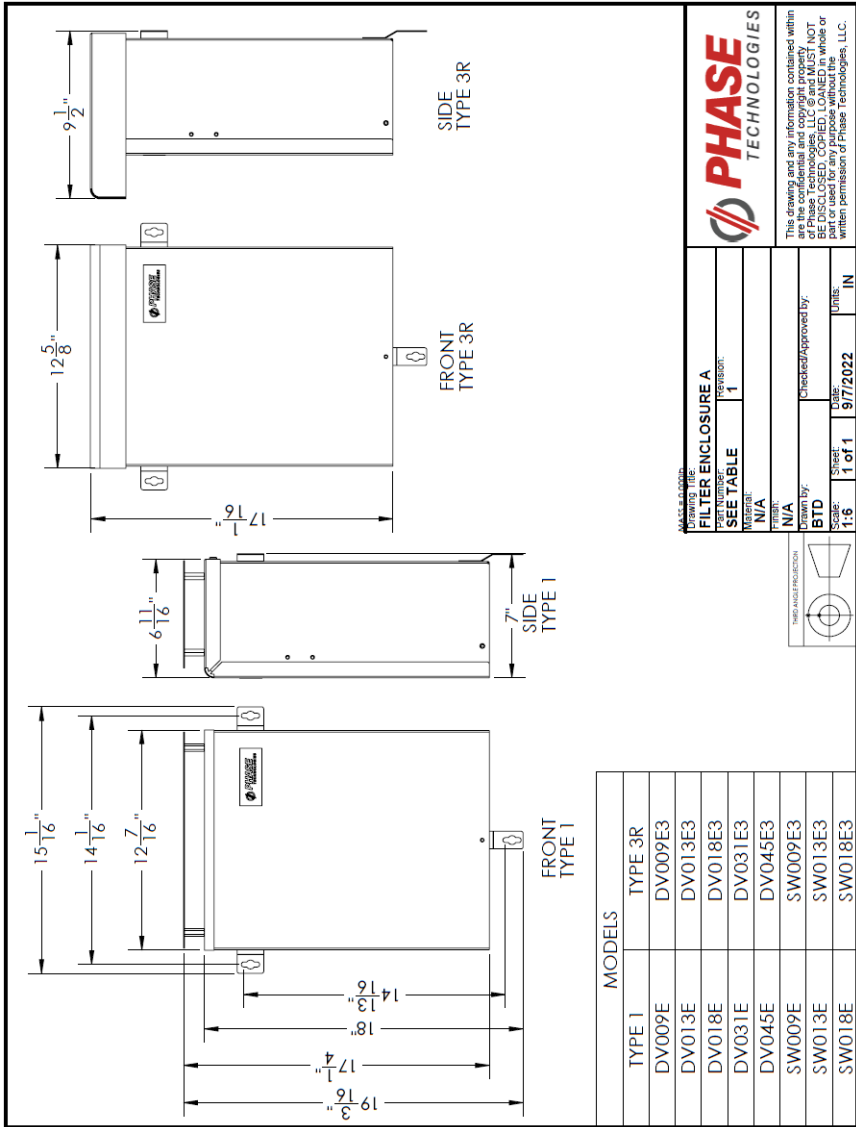

Figure 13 – Enclosure Dimensions, Enclosure A

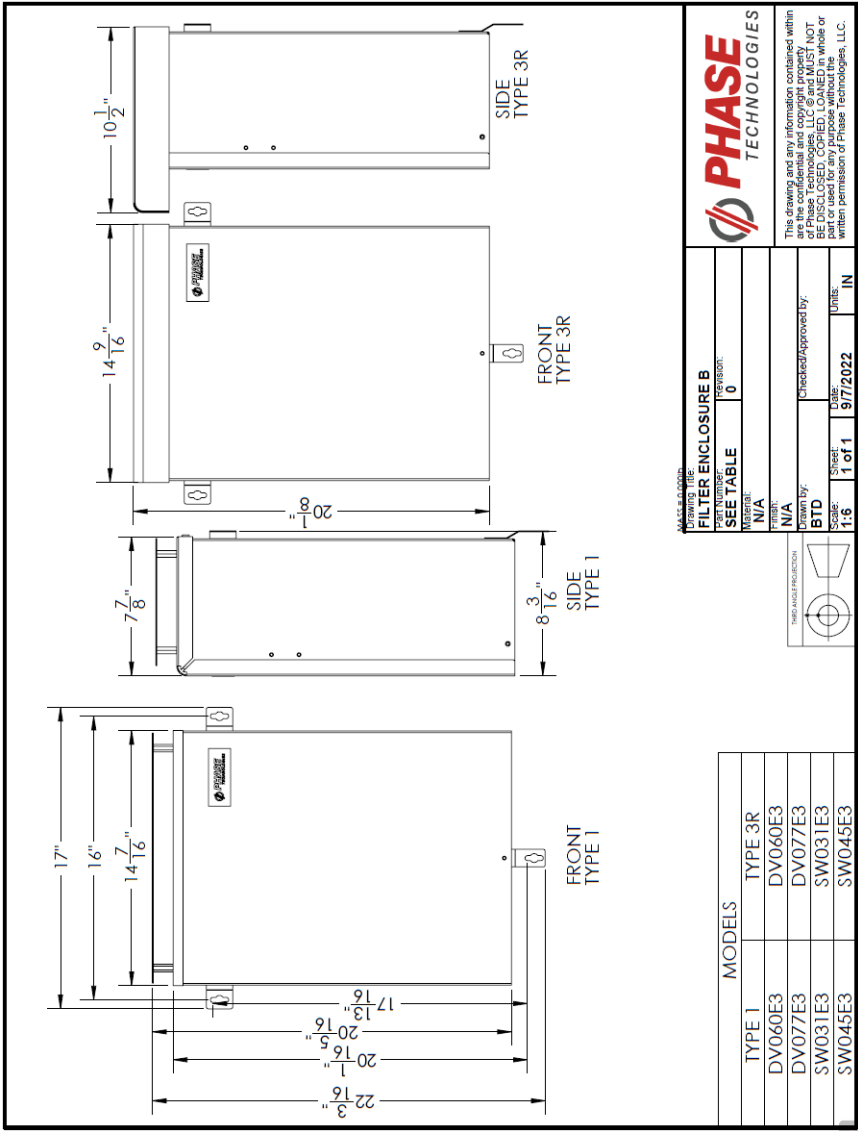

Figure 14 – Enclosure Dimensions, Enclosure B

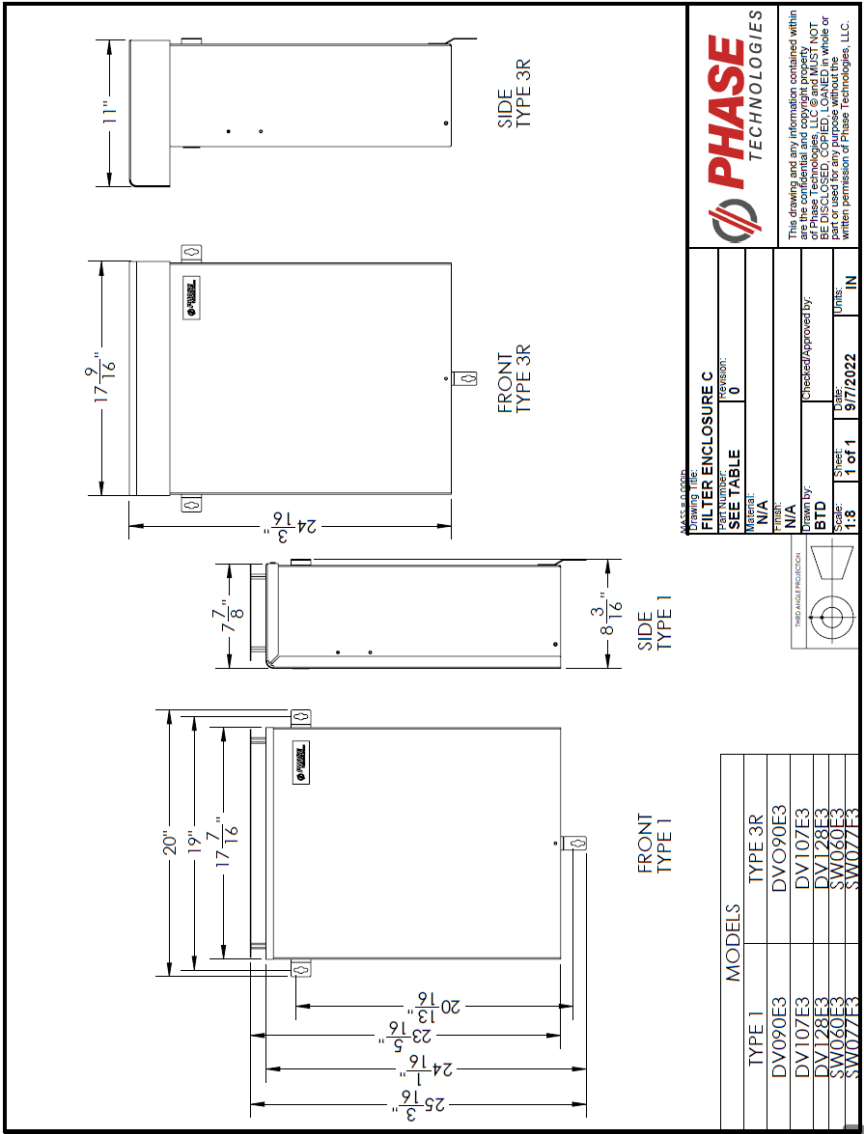

Figure 15 – Enclosure Dimensions, Enclosure C

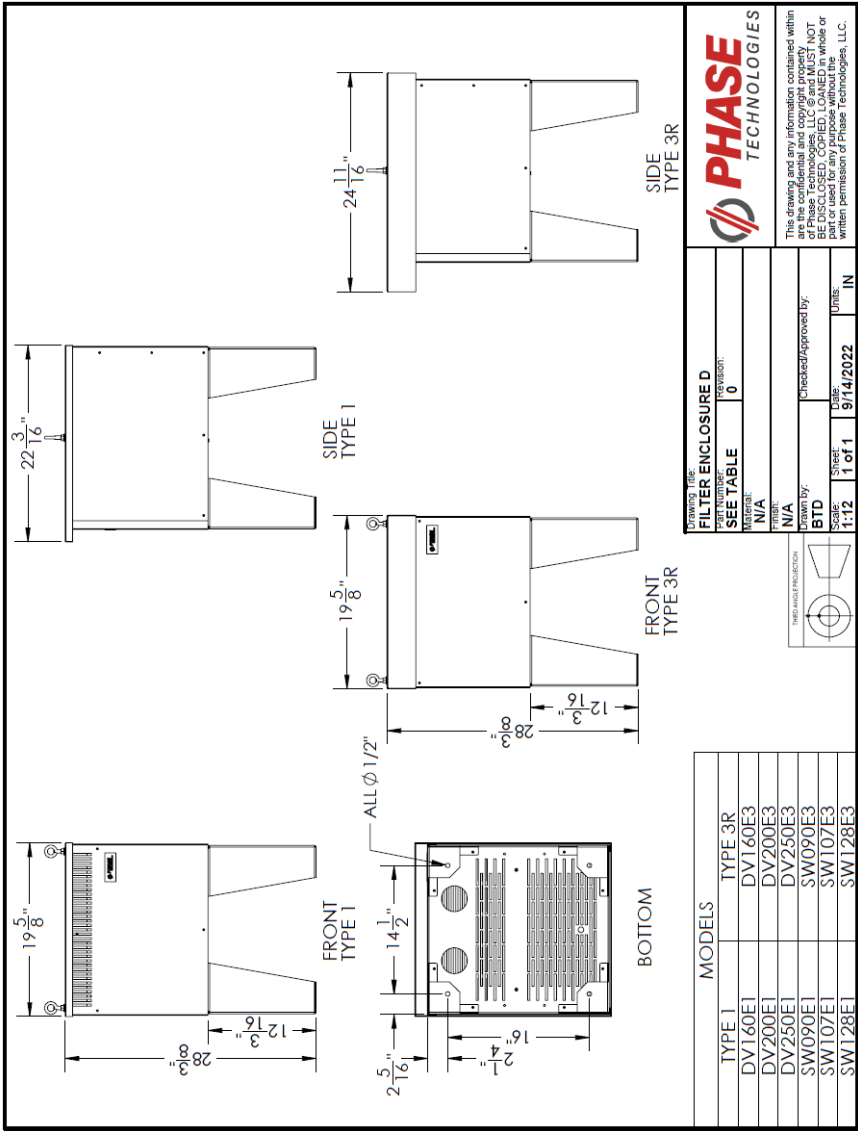

Figure 16 – Enclosure Dimensions, Enclosure D

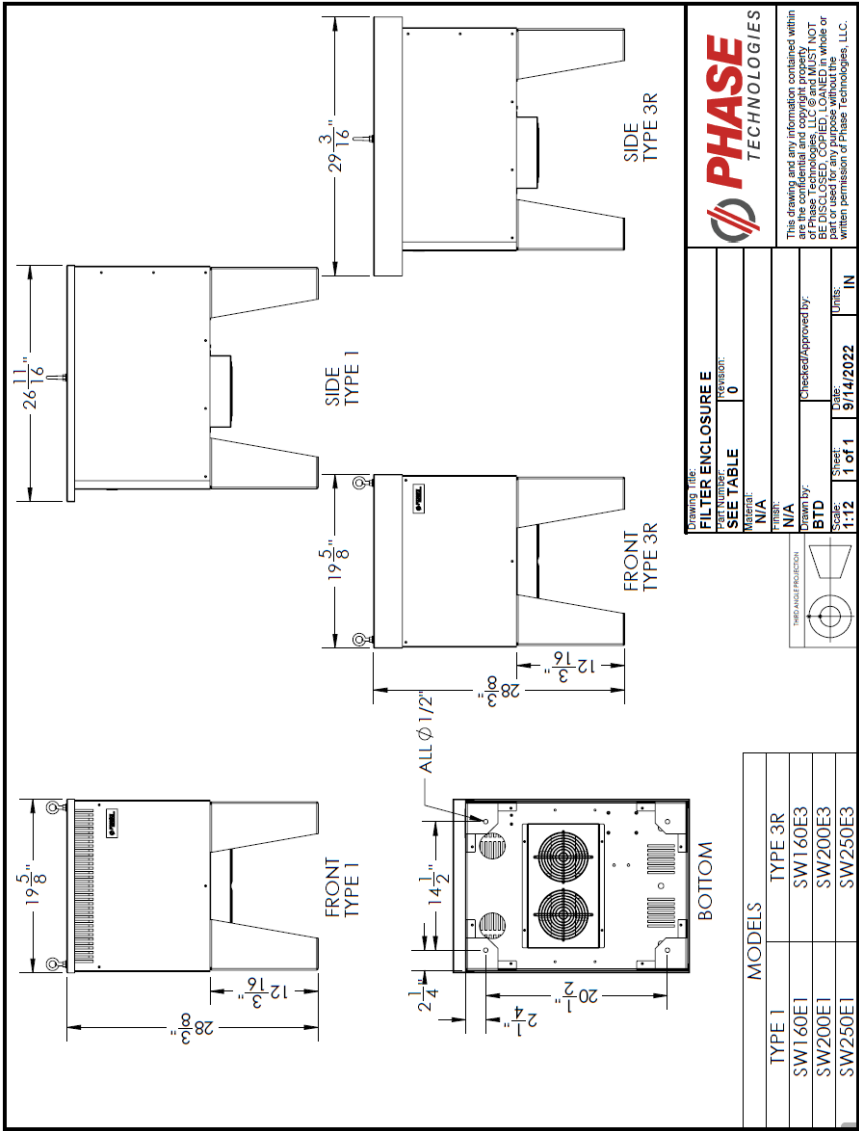

Figure 17 – Enclosure Dimensions, Enclosure E

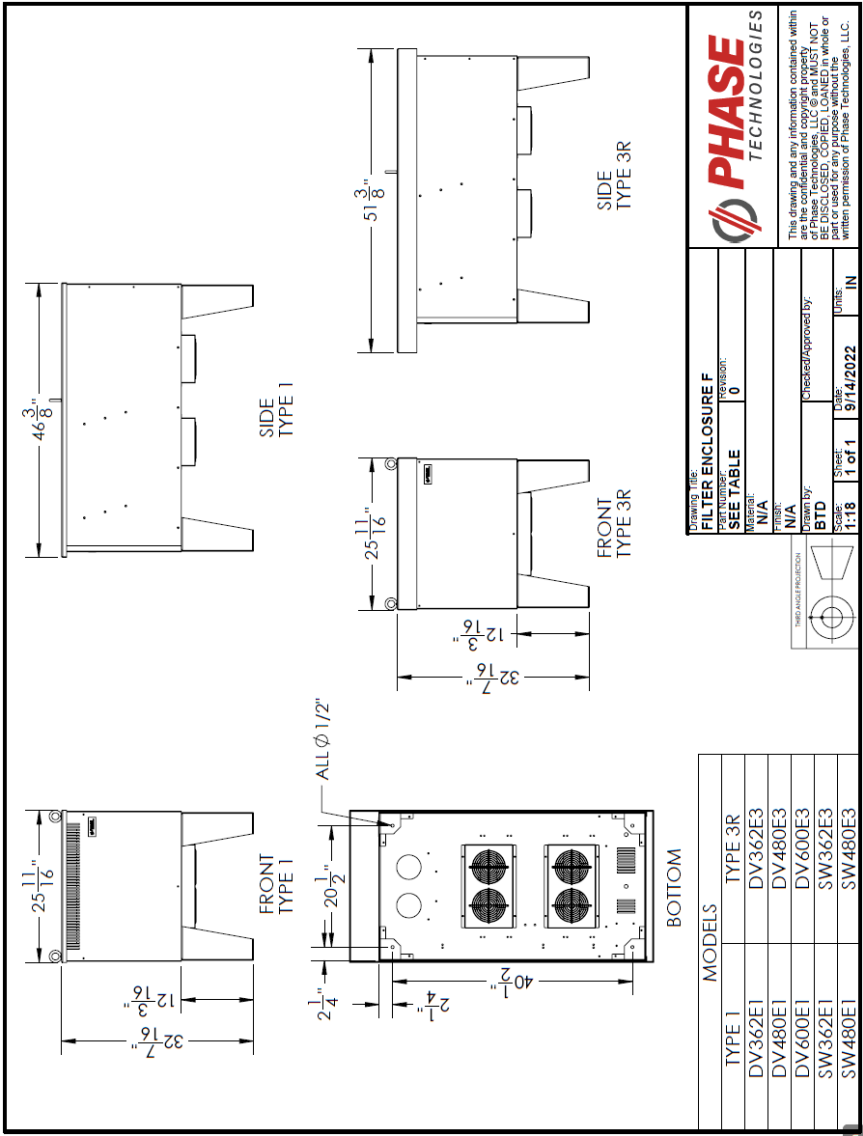

Figure 18 – Enclosure Dimensions, Enclosure F

6 NOTES



LIMITED WARRANTY

This Limited Warranty applies to the following
Phase Technologies' product lines:

Output Filters One Year Warranty

Output Filters are warranted against defects in material and workmanship. This warranty covers both parts and labor from the date of purchase from Phase Technologies. Phase Technologies will repair or replace (at our option), at no charge, any part(s) found to be faulty during the warranty period specified. The warranty repairs must be performed by/at a Phase Technologies Authorized Service Center or at Phase Technologies LLC, Rapid City, SD.

Obligations of Customer

1. The original Bill of Sale must be presented in order to obtain "in-warranty" service. Transportation to Phase Technologies or an Authorized Service Center is the responsibility of the purchaser. Return transportation is provided by Phase Technologies.
2. Installations must comply with all national and local electrical codes.

Exclusions of the Warranty

This warranty does not cover any of the following: accident, misuse, fire, flood, and other acts of God. Nor does this warranty cover any contingencies beyond the control of Phase Technologies, LLC, including: water damage, incorrect line voltage, improper installation, missing or altered serial numbers, and service performed by an unauthorized facility.

Phase Technologies' liability for any damages caused in association with the use of Phase Technologies' equipment shall be limited to the repair or replacement only of the Phase Technologies' equipment. No person, agent, distributor, dealer, or company is authorized to modify, alter, or change the design of this merchandise without express written approval of Phase Technologies, LLC.

Installations must comply with all national and local electrical code requirements.



222 Disk Drive, Rapid City, SD 57701

866-250-7934 - Toll-Free 605-343-7934 - Main

www.phasetechnologies.com
