

Product Manual

Variable Frequency Drives

DXLL SERIES

Six-Pulse | NEMA Type 1 | 2 - 5 HP

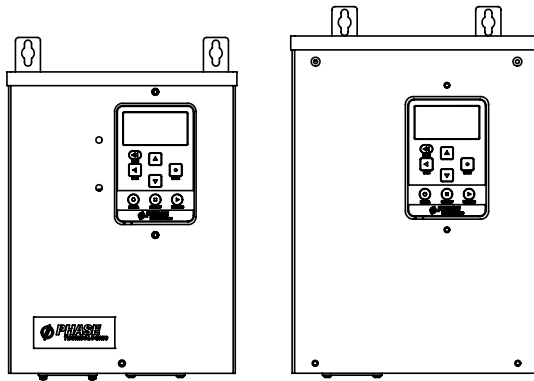

DXLL005
2 HP to 5 HP

DXLL405
2 HP to 5 HP



CONTACT INFORMATION

Address: 222 Disk Drive, Rapid City, SD 57701

Phone: 605-343-7934

Fax: 605-343-7943

Toll Free: 866-250-7934

www.phasetechnologies.com



#3187280

MADE IN U.S.A.

2024 © Copyright. V1.2 All rights reserved. All contents are property of Phase Technologies, LLC.

No portion of this publication or its contents may be duplicated by any means, electronic or otherwise, without the express written consent of Phase Technologies, LLC.

SAFETY MESSAGES AND WARNINGS

To ensure safe and reliable operation of the DXLL Series drives, it is important to carefully read this manual and to observe all warning labels attached to the unit before installation. Please follow all instructions exactly and keep this manual with the unit for quick and easy reference.

Definitions of Warning Signs and Symbols

 **CAUTION:** Indicates a potentially hazardous situation that could result in injury or damage to the product.

 **WARNING:** Indicates a potentially hazardous situation that could result in serious injury or death.

 **HIGH VOLTAGE:** The voltage associated with the procedures referenced could result in serious injury or death. Use caution and follow instructions carefully.

**READ THESE WARNINGS BEFORE INSTALLING
OR OPERATING EQUIPMENT!**

 **WARNING:** Risk of electric shock. More than one disconnect switch may be required to de-energize the equipment before servicing.

 **WARNING:** Risk of electric shock. De-energize the unit by disconnecting all incoming sources of power, then wait 10 minutes for internal charges to dissipate before servicing the equipment.

 **HIGH VOLTAGE:** This equipment is connected to line voltages that can create a potentially hazardous situation. Electric shock could result in serious injury or death. This device should be installed only by trained, licensed, and qualified personnel. Follow instructions carefully and observe all warnings.

 **WARNING:** This equipment should be installed and serviced by qualified personnel familiar with the type of equipment and experienced in working with dangerous voltages.

 **WARNING:** Installation of this equipment must comply with the National Electrical Code (NEC) and all applicable local codes. Failure to observe and comply with these codes could result in risk of electric shock, fire, or damage to the equipment.

 **CAUTION:** Circuit breakers, fuses, proper ground circuits, and other safety equipment and their proper installation are not provided by Phase Technologies, LLC, and are the responsibility of the end user.

 **CAUTION:** Failure to maintain adequate clearance may lead to overheating of the unit and cause damage or fire.

 **WARNING:** Input power connections should be made by a qualified electrician into circuit with adequate voltage and current carrying capacity for the model. Branch circuit protection to the unit should be provided by appropriately sized fuses or a circuit breaker.

 **CAUTION:** Use 600 V vinyl-sheathed wire or equivalent. The voltage drop of the leads needs to be considered in determining wire size. Voltage drop is dependent on wire length and gauge. Use only copper conductors.

 **CAUTION:** Wires fastened to the terminal blocks shall be secured by tightening the terminal screws to a torque value listed in **Table 3** and **Table 4**.

 **CAUTION:** The input wire gauge must be sized to accommodate the single-phase input current, which will be significantly larger than the three-phase output current to the load.

 **CAUTION:** The maximum wire gauge for the input terminals is listed in **Table 3** and **Table 4**.

 **CAUTION:** Never allow bare wire to contact metal surfaces.

 **CAUTION:** Never connect AC main power to the output terminals U, V, W.

 **WARNING:** Under certain conditions, the motor load may automatically restart after a trip has stopped it. Make sure power to the drive has been disconnected before approaching or servicing the equipment. Otherwise, serious injury may occur.

TABLE OF CONTENTS

1 INTRODUCTION	1
2 INSTALLATION	2
2.1 Mounting.....	2
2.2 Source Branch Circuit Protection	3
2.3 Installing Power Cables.....	3
2.4 Control Terminals	5
3 USING THE KEYPAD & DISPLAY	11
3.1 Display Modes	11
3.2 Password Protecting the Keypad.....	11
3.3 Keypad Display Messages.....	12
3.4 Keypad Main Menu Items	13
3.5 Change Parameter Values	13
3.6 Read Measured Values.....	13
3.7 Read Timers.....	14
3.8 Restart Log.....	15
3.9 Fault Log	16
4 ADJUSTABLE PARAMETERS	17
4.1 Changing Parameter Values	17
4.2 Restore Default Parameter Settings.....	17
4.3 Auto Restarts	18
4.4 Menu Structure Overview	19
5 OPERATION	27
5.1 Commissioning the Unit	27
5.2 Ground Fault Detection	27

5.3 Drive Set-up Procedure.....	28
5.4 Motor Overload Protection.....	29
5.5 System Configuration.....	29
Start-Up and Shut-Down Ramp Times	31
6 CONSTANT PRESSURE SYSTEMS.....	33
6.1 Control Principles of Constant Pressure Systems	33
6.2 Perfect Pressure™ Setup – Analog Constant Pressure.....	37
6.3 Analog Constant Pressure Systems.....	38
6.4 Precharge Mode.....	42
6.5 Lead/Lag Pump Control.....	43
6.6 Duplex / Multiplex Control.....	46
6.7 Tank Sizing.....	49
6.8 Troubleshooting Constant Pressure Systems	49
7 TROUBLESHOOTING	50
7.1 Fault Codes.....	50
7.2 Clearing a Fault.....	51
8 ROUTINE INSPECTION AND MAINTENANCE	54
9 MODELS AND RATINGS	55
9.1 Model Nomenclature	55
9.2 Model Ratings	55
9.3 Dimensional Drawings	56

1 INTRODUCTION

DXLL Series variable frequency drives (VFDs) are inverter-based devices that convert three-phase AC power to three-phase variable frequency output to provide speed control for three-phase AC motors. The drives offer advanced motor control features through an intuitive, easy to use interface.

The simplified block diagram below demonstrates how the drive converts the incoming single-phase AC power to DC, then utilizes an inverter module to generate three-phase variable voltage and frequency output to control the speed of the primary motor.

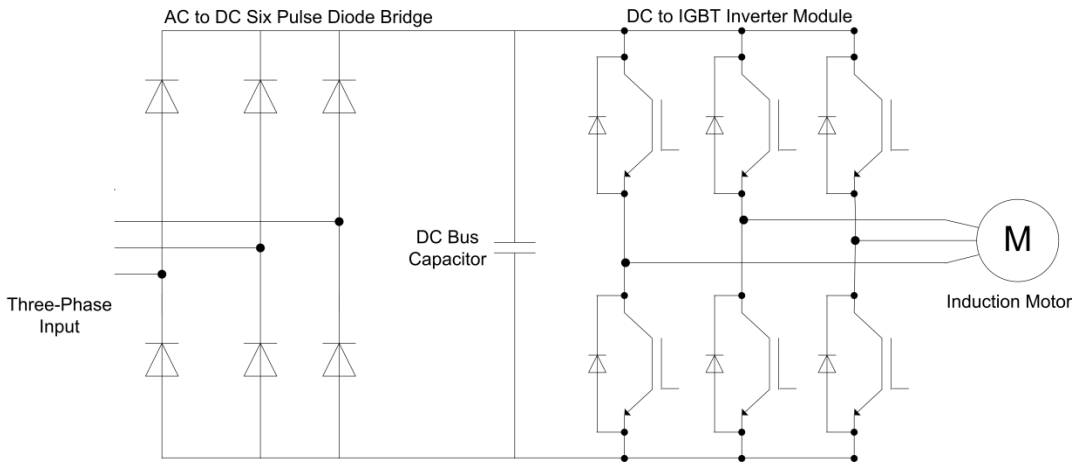

Figure 1 – DXLL Series Block Diagram

2 INSTALLATION

2.1 Mounting

The drive must be mounted in an upright position with adequate clearance for cooling and maintenance access. See **Section 9.3** for details. The mounting surface must be sturdy and capable of bearing the weight of the unit. Fasten the unit to the mounting surface using screws or bolts of an appropriate size through the holes on the mounting brackets. The enclosure can be wall mounted. Brackets for wall mounting are standard.

To allow for proper cooling and air circulation around the enclosure, maintain minimum clearance of six inches on the sides and top and 18 inches below. The drives are cooled by fans with ventilation openings on the side and bottom of the enclosure. The surface around the enclosure should be of a non-flammable material and clear of obstacles.

⚠ CAUTION: Failure to maintain adequate clearance may lead to overheating of the unit and cause damage or fire.

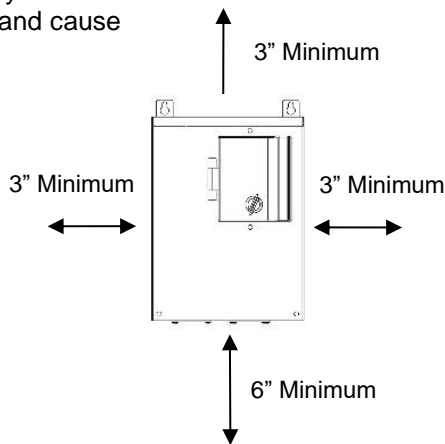

Figure 2 – Minimum Clearances

Ambient Temperature Rating

DXLL drives are intended for use in ambient temperatures of 40°C (104°F). Operation up to 50°C (122°F) is permissible with 2% de-rate per 1°C.

2.2 Source Branch Circuit Protection

Branch circuit protection must be installed in the circuit sourcing the drive. See **Table 1** for recommended circuit breaker/fuse sizing, which is based on 125% of the rated input current. Fuses may be used for circuit protection; consult local electrical code for proper sizing. Installation of a disconnect means within sight of the drive is recommended.

Table 1 – Fuse/Breaker Recommendations

Model	Input Current	Fuse/Breaker
DXLL002	9 A	15 A
DXLL003	12 A	15 A
DXLL005	18 A	30 A
DXLL402	4 A	15 A
DXLL403	5.4 A	15 A
DXLL405	9 A	15 A

2.3 Installing Power Cables

 **CAUTION:** Continuous metal conduit should be used on all power cables, both line and load side, to reduce conducted and emitted radiation of electromagnetic interference (EMI). The conduit must be securely grounded to the enclosure of the drive and the motor case. If any conduit holes remain unused, they must be covered with a 3R hole plug to maintain the NEMA 3R rating.

Mitigating Electromagnetic Interference (EMI)

Devices that utilize power switching electronics, such as VFDs, produce high frequency emissions commonly known as electromagnetic interference (EMI). These emissions can be conducted on power cables or emitted (radiated) through the air. Conducted and emitted noise can sometimes interfere with radio signals or sensitive electronic equipment near the installation. The use of shielded cables and rigid metal conduit on the output lines between the drive and the motor is recommended to help reduce EMI.

When it is not practical to use continuous metal conduit, special shielded cables can be used. The shielded cable should be constructed with symmetrical conductors and a copper or aluminum shield covered with an insulating jacket. A good shield results in lower EMI and lower motor bearing currents.

Routing Power Cables

Power cables should enter only through the bottom of the drive enclosure directly beneath the power terminals. Enclosures are supplied with conduit openings.

Do not install line-side power cables in the same conduit or cable tray with load side power cables. Also, do not route control cables through the same conduit or cable tray as power cables. Unused conduit holes must be covered with a conduit hole plug.

Routing Control Wires

A separate, smaller conduit opening is supplied for control cables. If the control cables must intersect the power cables, make sure they cross at right angles.

Connection to input and output power is made on the power terminal block. See **Table 2 - Table 4** for connection descriptions and **Figure 3** for terminal block locations.

Table 2 – Power Terminal Descriptions

Terminal Name	Description
L1, L2 (J1)	Input power terminals
U, V, W (J2)	Output power terminals
GND	Earth ground

Table 3 – Input Power Terminal Wiring Specifications

Input Power Terminals	
Model	
DXLL002, DXLL003, DXLL005, DXLL402, DXLL403, DXLL405	
Wire Size	Torque
20–6 AWG	15 lb-in

Table 4 – Output Power Terminal Wiring Specifications

Output Power Terminals	
Model	
DXLL002, DXLL003, DXLL005, DXLL402, DXLL403, DXLL405	
Wire Size	Torque
20–6 AWG	10.5 lb-in

Backup Generator Power

If using a backup generator and automatic transfer switch to power the VFD, a delay timer must be used when switching between power sources. The delay must be long enough for the VFD screen to go dark before re-applying power – approximately 15 – 30 seconds.

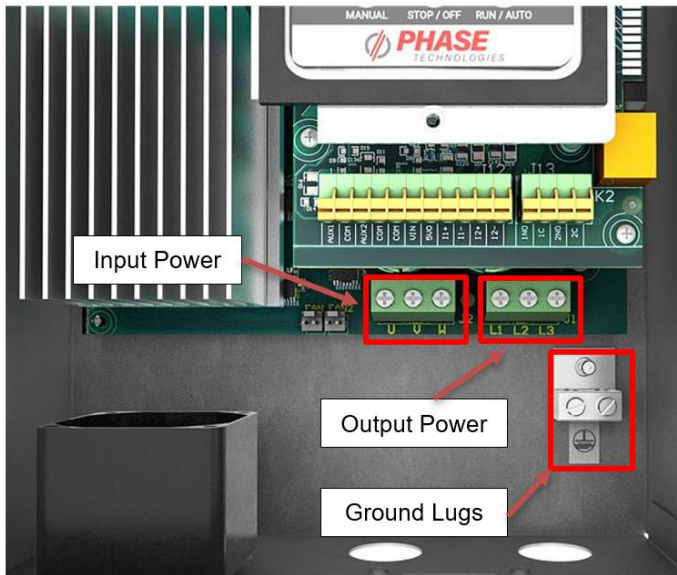

Figure 3 – Power Terminal Location, DXLL

Output Filters

Some installations may require a load reactor or sine wave filter between the drive and the motor. A filter reduces harmonics in the PWM output voltage, smoothing the waveforms to reduce vibration in the motor. Filters also reduce common mode currents in the cabling and motor windings that can discharge through motor bearings, causing pitting and premature motor failure.

2.4 Control Terminals

DXLL Series drives are equipped with control terminals that allow several control functions, including remote ON/OFF control, digital output signals, and remote notification, operation of constant pressure water systems.

The correct System Configuration must be selected for proper operation of the different types of control systems! See **Table 12, Interface Parameters**, for details.



WARNING: Risk of electric shock. De-energize the unit by disconnecting all incoming sources of power, then wait 5 minutes for internal charges to dissipate before servicing the equipment.

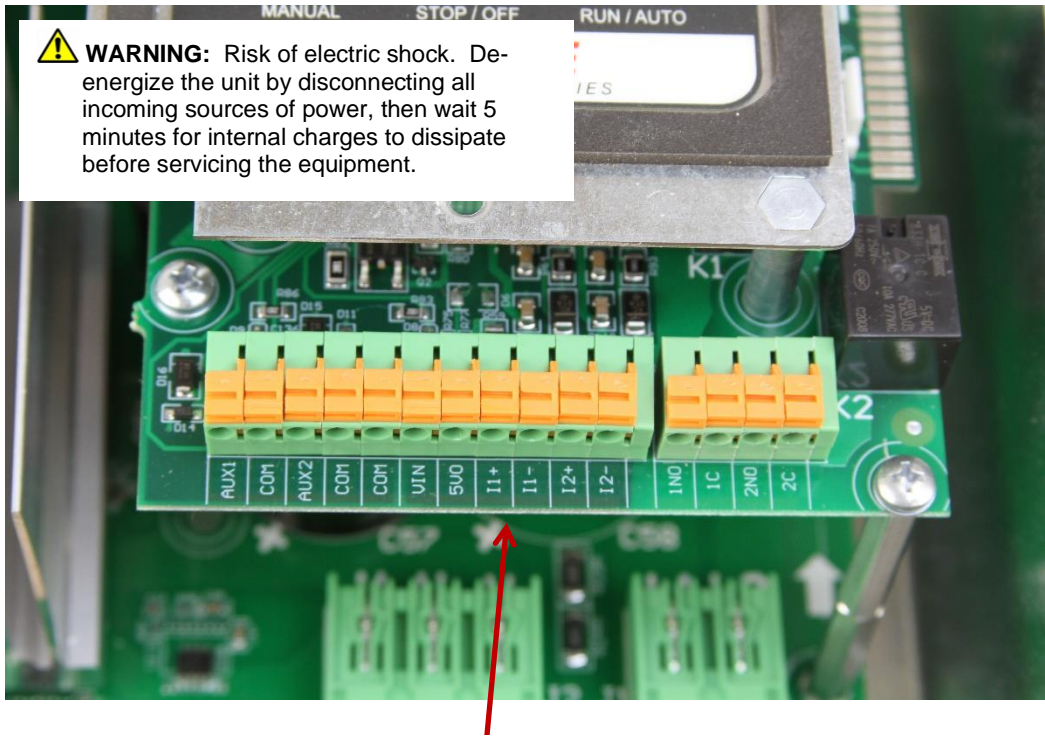

Control terminals are located on the Control printed circuit board.



CAUTION: Use care not to damage other components on the printed circuit board when removing and replacing the control terminal blocks.

Figure 4 – DXLL Control Terminal Closeup





WARNING: Do not connect control terminals to external circuits with voltage greater than that specified for each control terminal in **Table 5**. Disconnect all incoming sources of power, and then wait 5 minutes for internal charges to dissipate before servicing the equipment.



CAUTION: The AUX1 and AUX2 terminals are galvanically isolated, with approximately 5 V potential between them. DO NOT apply voltage to the terminals. Use dry contacts only.

Table 5 - Control Terminal Ratings and Descriptions

Terminal Designator	Description	Rating	Comments
1NO	Normally Open Relay	0-30 VDC or 230 VAC, 10 A	Normally open relay controlled by parameter PROGRAM RLY 1 . See Table 12 , for instructions on programming this relay.
1C	Common		Common terminal for 1NC and 1NO terminals.  CAUTION: This terminal is common only for 1NO and 1NC. Do not use as common for other terminals.
2NO	Normally Open Relay		Normally open relay controlled by parameter PROGRAM RLY 2 . See Table 12 for instructions on programming this relay.
2C	Common		Common terminal for 2NC and 2NO terminals.  CAUTION: This terminal is common only for 2NO and 2NC. Do not use as common for other terminals.
I1+	4-20 mA positive	4-20 mA	Analog transducer connection for analog constant pressure or proportional motor speed control from a current source. Refer to Table 12 or Section 5.5, System Configuration , for details. See Figure 6 for a connection diagram to control terminals.
I1 –	4-20 mA negative		
I2+	4-20 mA positive		
I2–	4-20 mA negative		
5 VO	0-5 VDC output	0-5 VDC	5 VDC supply to provide power to a potentiometer. Refer to Table 12 or Section 5.5 for details. See Figure 4 for a connection diagram to control terminals.
V In	0-5 VDC input		Analog input for motor speed control for 0-5 VDC. Speed is relative to scale of signal from 0 Hz to Maximum Frequency as set in Adjustable Parameter menu (default 60 Hz). See Figure 5 for a connection diagram.
COM	Common		Common for 0-5 VDC. See Figure 5 for a connection diagram.
COM	Common	< 5 volts, galvanically isolated	Common terminal for AUX1 or AUX2
AUX1	Auxiliary 1		Programmable digital input. Commonly used for RUN/STOP command. Controlled by parameter AUX1 SELECT . See Table 11, Auto Restart Parameters , and Section 5.5 for details.
COM	Common		Common terminal for AUX1 or AUX2
AUX2	Auxiliary 2		Programmable digital input. Commonly used for RUN/STOP command. Controlled by parameter AUX2 SELECT . See Table 11, and Section 5.5 for details.

0-5 VDC Potentiometer

Follow these steps to connect a 0-5 VDC potentiometer to analog input:

Using the keypad, set the value of parameter **SYSTEM CONFIG** to 2. Refer to **Table 12** or **Section 5.5, System Configuration**, for details.

1. Connect the negative lead of the potentiometer to Control Terminal **COM**.
2. Connect the wiper terminal of the potentiometer to the **V IN** terminal.
3. Connect the positive lead of the potentiometer to the **5 VO** terminal.

⚠ CAUTION: By default, **AUX1** and **AUX2** are programmed to be always in **RUN** mode. Opening or closing **AUX1** and **AUX2** to **COM** will not affect drive operation. See parameters **AUX1 SELECT** and **AUX2 SELECT** to change this setting.

⚠ CAUTION: The resistance value of the transducer must be from 5,000 ohms to 20,000 ohms. Resistance below 5,000 ohms will produce a high current in the circuit and may damage components in the circuit.

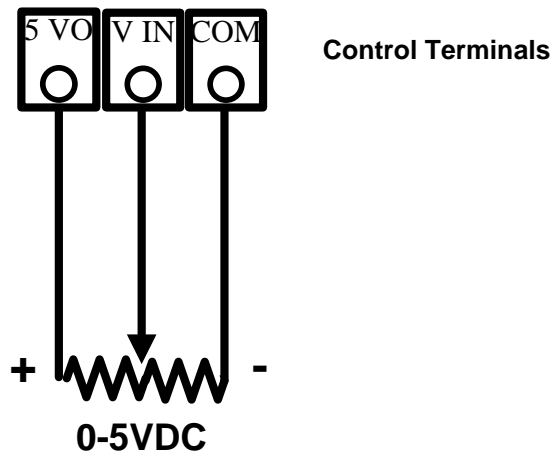

Figure 5 - Connection Diagram for 0-5VDC Transducer (Potentiometer)

4-20 mA Analog Transducer

Follow these steps to connect a 4-20 mA transducer:

Using the keypad, set the value of parameter **SYSTEM CONFIG** to 1 or 3 depending on the desired mode of operation. See **Table 12** and **Section 5.5, System Configuration**, for details.

1. Connect the positive lead of the transducer to terminal I_1+.
2. Connect the negative lead of the transducer to terminal I_1-.

⚠ CAUTION: By default, **AUX1** and **AUX2** are programmed to be always in **RUN** mode. Opening or closing **AUX1** and **AUX2** to **COM** will not affect drive operation. See parameters **AUX1 SELECT** and **AUX2 SELECT** to change this setting.

⚠ CAUTION: A 4-20 mA transducer with the parameter **SYSTEM CONFIG** set at 3 results in linear speed control of the motor based on the analog signal from the transducer. This setting will not provide control of a constant pressure water system. For constant pressure control with 4-20mA transducer, refer to **Section 5.5, System Configuration**, and **Section 6, Constant Pressure Water Systems**, for more information.

⚠ CAUTION: If the I_1+ and I_1- or the I_2+ and I_2- sensor cable is short circuited or if the sensor fails, the drive will stop and indicate a fault, **SENSOR CONNECTION FAIL**. Disconnect input power to the drive and fix the short circuit or replace the sensor.

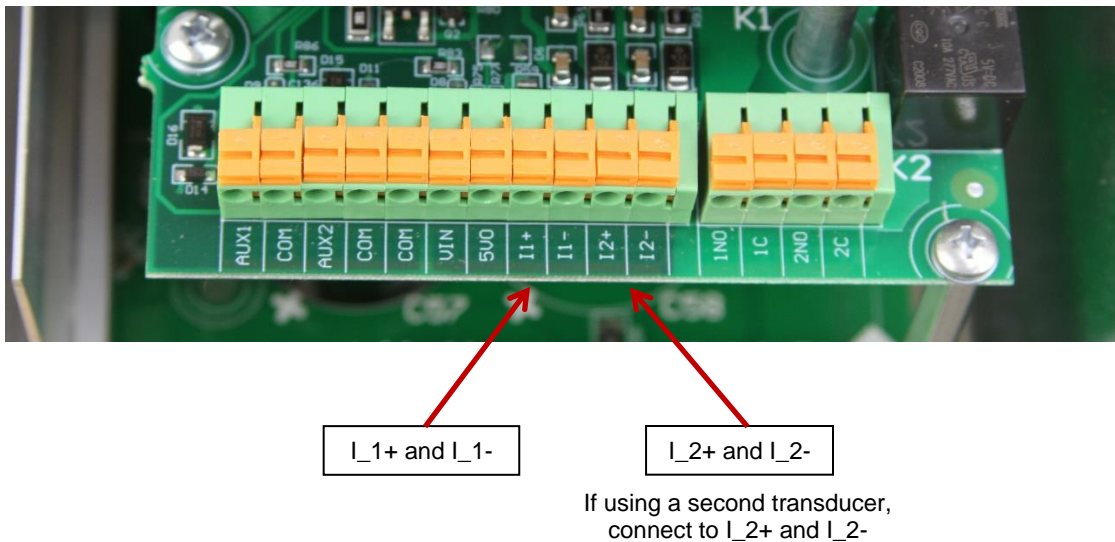

Figure 6 - Connections for 4-20 mA Transducer

Analog Constant Pressure with Potentiometer and HOA Switch

The drives can be configured with a HOA switch that allows the user to either turn the motor off, control motor speed with a potentiometer, or operate in constant pressure mode. Access to the keypad is not required to operate in this mode.

1. Using the keypad, set the value of parameter **SYSTEM CONFIG** to 4. See **Table 12** for details.
2. Connect the potentiometer and 4-20 mA transducer as in **Figure 5** and **Figure 6**.
3. Connect a double pole, triple throw switch to AUX1 and AUX2 as shown in **Figure 7**.
4. Using the keypad, set the drive to operate in AUTO mode.
5. AUX1 to COM must be closed to run.

The mechanical HOA switch allows the user to select between OFF, manual speed control with the potentiometer, or analog constant pressure. In the H (manual) position, motor speed is controlled by the potentiometer. In the O (off) position the motor will stop. In the A (auto) position motor speed will be controlled by constant pressure parameters.

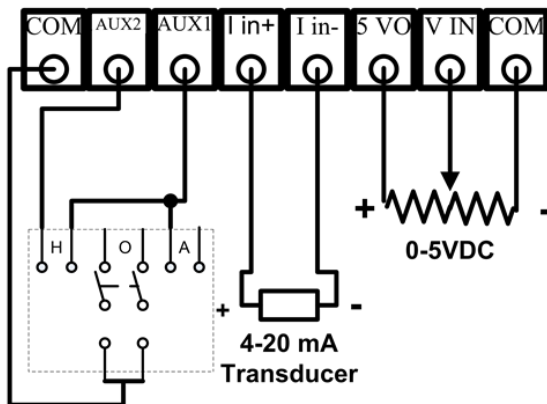

Double pole, triple throw HOA switch

CAUTION: When the HOA switch is in the manual (H) position, the drive will ignore the status of AUX2 Control Terminal.

Figure 7 - Connections for Analog Constant Pressure with Potentiometer and HOA Switch

3 USING THE KEYPAD & DISPLAY

DXLL Series drives are capable of many advanced, easy-to-use features that allow the user to protect the motor load from damage, monitor load conditions, log motor run time, troubleshoot the system, and more. The keypad is easy to use and understand, with 32-character text messages and an intuitive interface specifically tailored for pumping applications.

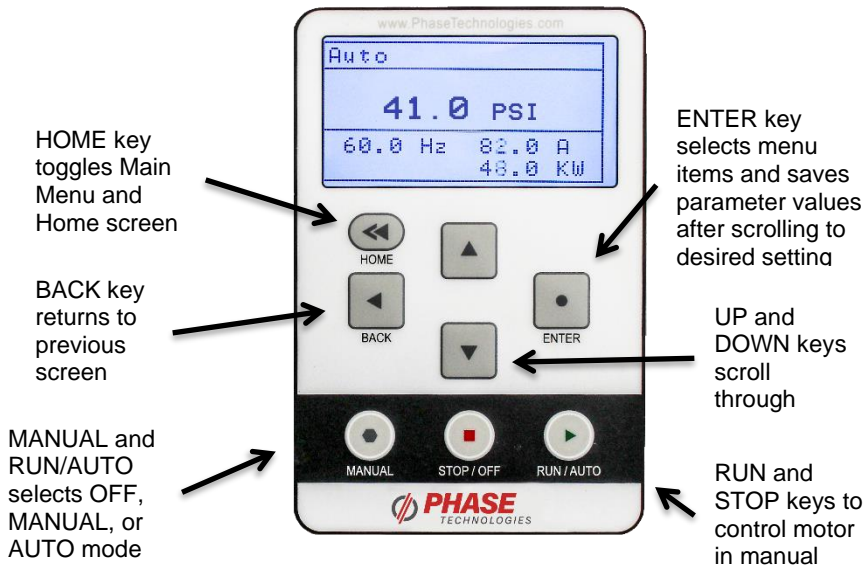

Figure 8 – Keypad and Text Display

3.1 Display Modes

After two minutes of keypad inactivity, the display will revert to the default display mode. Information on the display will vary based on the operating mode of the drive. When operating in AUTO mode with the factory default **SYSTEM CONFIG = 0**, the display will indicate output kilowatts (kW), output amps (A), output frequency (Hz) and the status of the AUX1 and AUX2 inputs.



3.2 Password Protecting the Keypad

The keypad can be set up with a password to prevent unauthorized changes in adjustable parameters. The parameter **PASSWORD SETUP (Table 12)** is used to protect the keypad. When this parameter has a value of zero the keypad is not protected. To password protect the keypad, enter a password consisting of four digits. Passwords can contain numbers 0 through 9 or letters A through F. Contact customer service at 605-343-7934 if you lose or forget the password.

3.3 Keypad Display Messages

Several messages will appear on the display when the unit is initially energized. When the unit has completed its start-up routine, the default display indicating the status of the OFF, AUTO, MAN mode will appear. Start-up display messages are detailed in **Table 6** below.

Table 6 - Display of Operating Modes

MODE	DESCRIPTION
AUTO	<p>The factory default operating mode is OFF. The adjustable parameter, ENABLE RESTARTS, must be set to YES to allow automatic re-starts. See Table 10, <i>Operating Parameters</i>, for details.</p> <p> CAUTION: By default, AUX1 and AUX2 are programmed to be always in RUN mode. Opening or closing AUX1 and AUX2 to COM will not affect drive operation. See parameters AUX1 SELECT and AUX2 SELECT to change this setting. See Table 12 for details.</p>
MANUAL	<p>Activate MANUAL mode by pushing the MANUAL key until MANUAL appears on top left of the display. In MANUAL mode the motor load is controlled by using the RUN and STOP keys, which will override the AUX1 and AUX2 remote switches.</p> <p>Manual control of the drive through the keypad can be disabled through the parameter DISABLE MANUAL. See Table 12 for details.</p> <p> CAUTION: Operating the system in MANUAL mode on the keypad overrides signals from the pressures switches. Operating the system in this mode may lead to dangerous pressures in closed plumbing systems.</p> <p> CAUTION: If the 4-20 mA or 0-5 VDC control terminals are short circuited, power will be lost to the keypad. If the drive is in MANUAL RUN mode, the drive will not respond to a STOP command on the keypad. Disconnect input power to the drive and then fix the short circuit.</p>
OFF	<p>The factory default operating mode is OFF. The parameter, ENABLE RESTARTS, must be set to YES to allow automatic re-starts. To exit AUTO mode, press the STOP/OFF key until OFF appears on top left of the display. If the motor is running, it will stop. To restart the motor, revert to either AUTO mode or MANUAL mode. Certain faults can also be cleared by pressing the up and down arrow keys at the same time and holding for one second.</p>

3.4 Keypad Main Menu Items

The HOME key toggles between the Home screen (operating status screen) and the Main Menu items. Use the UP and DOWN arrows to scroll through the Main Menu items. Press ENTER to view or edit a Main Menu item. **Table 7** contains a brief description of Main Menu items, followed by instructions on the use and function of each Main Menu item.

Table 7 – Main Menu Items

DISPLAY MESSAGE	DESCRIPTION
CHANGE PARAMETER VALUES	Allows the user to set values for functions such as motor overload settings, dry well condition, time to restart after a fault, etc.
READ MEASURED VALUES	Displays measured values such as output current, input voltage, power factor, etc.
READ TIMERS	Records motor run time and drive on time.
RESTART LOG	A re-settable fault log that records the number of times a particular fault has occurred. The number of faults counted in this log can be cleared through the CLEAR MEMORY menu.
FAULT LOG	Records the number of times a particular fault has occurred. FAULT LOG cannot be reset by the user.
CLEAR MEMORY	This function clears the Restart Log and Timers. <u>A</u> ll fault counters in the Restart Log will be reset to zero. If any number of automatic restarts have been allowed through parameters in Auto Restart Parameters, the counter will be set to zero.

3.5 Change Parameter Values

The Main Menu item, **CHANGE PARAMETER VALUES**, leads to several sub-menus that contain adjustable operating parameters. These parameters provide basic functions such as motor overload protection and advanced features that allow you to customize the operation of the drive to fit your application.

Section 4, starting on page 17, contains a complete list of the parameters along with a description of their function and instructions on setting them.

3.6 Read Measured Values

The display can provide a variety of measured values related to the performance of the drive and its load, such as currents, bus voltage, and 4-20 mA readings. To read measured values:

1. Press the HOME key to access Main Menu items, and then scroll with arrow keys until **READ MEASURED VALUES** appears on the display.
2. Press ENTER to access this menu item.
3. Use the up and down arrow keys to scroll through the various values that you wish to read.



Programming Tip

Press the HOME key at any time to return to the Home screen (operating status screen).

Table 8 – Measured Values

DISPLAY MESSAGE	DESCRIPTION OF MEASURED VALUE
I _u I _v I _w	Output currents
Output kVA	Output measured in kVA
Bus Cap Voltage	Voltage of the DC bus
Input Voltage	Input voltage AC
Aux1 Aux2	ON/OFF status of the remote switch circuits AUX1 and AUX2
Frequency	Output frequency in Hz
Model Number	Displays the product model number
5VDC Input	Measures the 0-5 VDC analog control voltage between Control Terminals for 0-5VDC input.
I ₁ 4-20mA IN	Measures 4-20 mA analog control current on I ₁ Control Terminals for analog current input.
IGBT CASE TEMP	IGBT case temperature.

3.7 Read Timers

The timer function records the motor run time and the time the drive has been energized. There are two timers for each function, one which can be reset, and one permanent. To view and reset the timers:

1. Press the MENU key to scroll through menu items until **READ TIMERS** appears on the display.
2. Press ENTER to enter this menu item.
3. Use the UP and DOWN arrows to scroll through the clock functions.
4. To reset the clock timers, navigate to the Main Menu item, **CLEAR MEMORY**, press ENTER, and then use arrow keys to select **RESET TIMERS**. Press ENTER to reset the timers.

Table 9 - Timers

TIMER	DESCRIPTION
Motor Run Time	Logs motor run time in hours.
Drive On Time	Logs time in hours the drive is energized
All Motor Hours	Logs total motor run time. Not resettable.
All Drive Hours	Logs total time the drive is energized. Not resettable.



Programming Tip

To reset the timers, navigate to the Main Menu item, **CLEAR MEMORY**, use arrow keys to select **RESET TIMERS**, and then press ENTER.

Clear Memory

The **CLEAR MEMORY** function in the Main Menu allows you to reset the timers that record motor run time and drive on time, and to reset the Restart Log which counts the instances of each fault.

1. Press the HOME key then use the UP and DOWN arrows to scroll through menu items until **CLEAR MEMORY** appears on the display.
2. Press ENTER to enter this menu item.
3. Use the UP and DOWN arrows to find either **RESET TIMERS** or **CLEAR RESTART LOG**.
4. Press ENTER to reset the selected function.

3.8 Restart Log

The Restart Log records the number of times each fault has occurred. The fault counters in the Restart Log are resettable and are tied to faults that allow programmable automatic restarts. These automatic restarts are programmed through the **AUTO RESTART PARAMETERS**, which is a sub-menu of the **CHANGE PARAMETER VALUES** Main Menu item.

For instance, in a water well pump application, it might be useful to protect the pump from dry well condition by setting the **DRY WELL CURRENT** parameter (found in the **OPERATING PARAMETERS** menu) so that the drive shuts down and registers a **DRY WELL CURRENT** fault in the Restart Log.

The drive can also be programmed to automatically restart after a delay to allow time for the well to recover. Both the time of the delay and the number of restarts allowed can be programmed through the **AUTO RESTART PARAMETERS**. The Restart Log allows the user to monitor the type and number of faults that have occurred. If the number of dry well faults exceeds the number of automatic restarts allowed for that fault, the drive will remain OFF until the Restart Log is cleared, which resets ALL resettable fault counters. See *Auto Restarts* in **Section 4.3** and refer to **Table 11** for more information.

To view the Restart Log:

1. Press the HOME key then use the UP and DOWN arrows to scroll through menu items until **RESTART LOG** appears on the display.
2. Press ENTER to access this menu item.
3. Use the UP and DOWN arrows to scroll through the faults.
4. The fault will appear on the first row of the display, followed by the number of times that fault has occurred.

To clear the Restart Log and reset all Auto Restart fault counters:

1. Press the HOME key then use the UP and DOWN arrows to scroll through the Main Menu items until **CLEAR MEMORY** appears on the display.
2. Press ENTER.
3. Use the UP and DOWN arrows to find **CLEAR RESTART LOG**.
4. Press ENTER to clear the Restart Log and reset all Auto Restart fault counters.

 **CAUTION:** Clearing faults through the **CLEAR MEMORY** menu will clear ALL faults in the Restart Log and all fault counters will be reset to zero. If any number of automatic restarts have been allowed through the Auto Restart Parameters (**Table 11**), the counter on these faults will be set to zero.

When the drive has faulted and is programmed to automatically restart after a time delay, the display will count down the remaining time to start. Press and hold both the UP arrow and DOWN arrow for one second to interrupt the countdown and start the motor.

If the drive has faulted and no auto restart is allowed, the display will indicate the type of fault that has occurred on the top line and the second line will read **RESTART? ENTER**. Press ENTER to clear the fault and restart the load. The number and type of faults are also recorded in the Fault Log. In this Log each fault is recorded with a time and date stamp (up to the most recent 20 faults). The Fault Log is permanent and cannot be cleared. See **Section 3.9** for more information on the Fault Log.

3.9 Fault Log

The Fault Log is a permanent record of drive faults. The number of faults cannot be reset by the user.

The Fault Log is a Main Menu item. Navigate through the Main Menu items by pressing the HOME key then use the UP and DOWN arrows until FAULT LOG appears. Press ENTER to view the list of faults, using the arrow keys to scroll through the list.

4 ADJUSTABLE PARAMETERS

4.1 Changing Parameter Values



WARNING: When the drive is set to automatically restart after a fault, the output terminals can energize and the load can start without warning, exposing the user to risk of serious injury. Make certain the input is de-energized before approaching the equipment. The unit can be programmed to automatically restart after certain faults. The factory default setting does not allow automatic restart. Use caution if automatic restart is enabled.

The **CHANGE PARAMETER VALUES** function allows the user to set values for a variety of functions including motor overload settings, number of restarts after a fault, ramp time, maximum frequency, and more. To change parameter values:

1. Press the HOME key until **CHANGE PARAMETER VALUES** appears on the display.
2. Press ENTER to access this menu item.
3. There are multiple sub-menu items under **CHANGE PARAMETER VALUES**. Use the UP and DOWN arrows to scroll through the sub-menu to find the item desired, then press ENTER. See **Table 10** through **Table 14**, for a list of parameters and descriptions of each.
4. Use the UP and DOWN arrows to scroll to the parameter you want to set, press ENTER, then use the UP and DOWN arrows to select a new value for that parameter.
5. When the value you want appears on the display, press ENTER to set the new value.
6. To escape the parameter without selecting or resetting the value, press the BACK key, which will return you to the list of parameters.



Programming Tip

Press the ENTER key to move to lower levels of the menu outline or to save a new parameter value. Press the BACK key to move to higher levels in the menu outline or to escape a parameter setting without changing the value.

4.2 Restore Default Parameter Settings

To restore **ALL*** adjustable parameters to their default value, press and hold the **BACK** and **ENTER** keys at once and hold for three seconds. The display will read “**RESET PARAMETERS TO DEFAULT? ENTER = YES, BACK = NO.**” Press **ENTER** to reset and reboot the drive.

If a User Password is configured, you will first be prompted to enter the Password. You will then be prompted to press **ENTER** for yes or **BACK** for no.”

*Important Note:

The restore function will not affect the following: **REVERSE ROTATION**, **USER PASSWORD**, and **SWITCHING FREQUENCY**.



Programming Tip

Make sure to press both keys at once and hold 3 seconds. This reset function is disabled while the motor is running. Make certain the motor is stopped before resetting.

 **CAUTION:** This action will reset **ALL (except for *REVERSE ROTATION*, *USER PASSWORD* and *SWITCHING FREQUENCY*)** programmable parameters to the default value. To reset an individual parameter to its default value, you must refer to the appropriate table of Adjustable Parameters, find the default value, re-enter that value and save it. See **Table 10** through **Table 14** for a complete list of adjustable parameters, their description, and default/minimum/maximum values.

4.3 Auto Restarts

The drive can be programmed to automatically restart after certain faults. Using the **Auto Restart Parameters (Table 11)**, you can set a time delay before the drive starts after a fault and select the number of automatic restarts allowed before the unit will remain OFF after a fault.

For example, you may wish to allow 10 automatic restarts after a fault for dry well but require the drive to remain off for one hour to allow the well to recover before restarting. When the drive is counting down the time to restart after a fault, the display will indicate the time until restart (in seconds).



Programming Tip

To interrupt a countdown and allow a restart, push and hold both the UP and DOWN arrow keys for one second. The load will start immediately.

When the drive reaches the limit of faults set by the adjustable parameter, it will remain OFF and the display will indicate the type of fault on the top line. The second line will read **RESTART? ENTER**. Press ENTER to clear the fault and restart the load. The fault counters in the Restart Log will all be reset to zero. See **Section 3.8, Restart Log**, for more information.

Some faults do not allow auto restart. The display will read **NO AUTO RESTART**. See **Section 3.9, Fault Log**, for more information.

4.4 Menu Structure Overview

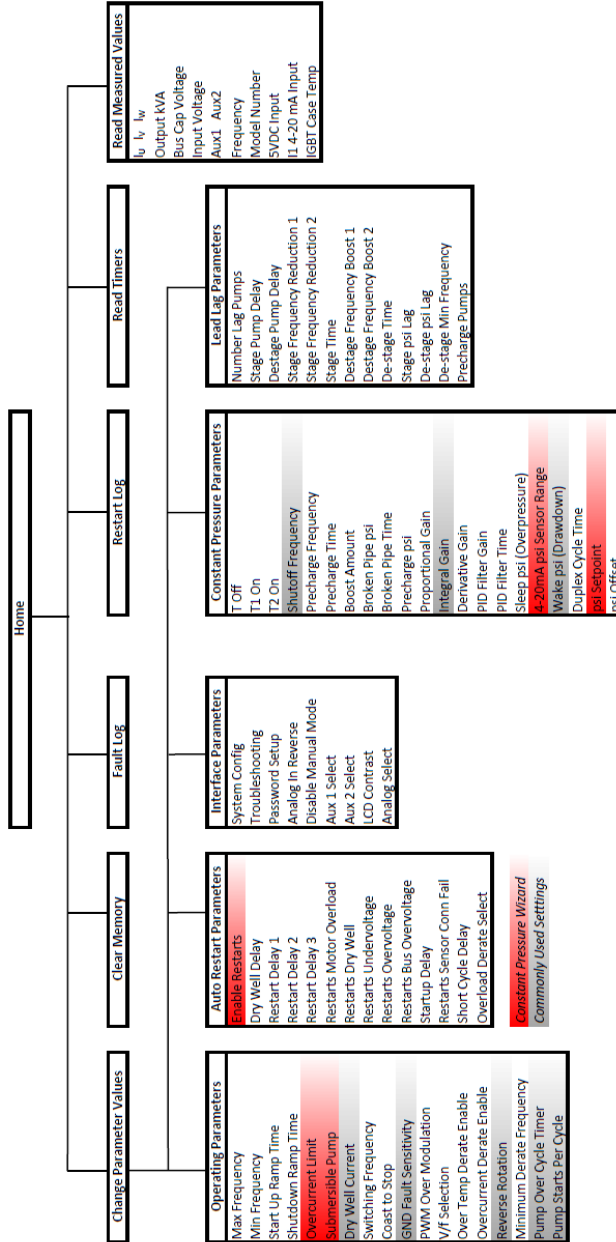

Table 10 - Operating Parameters

DISPLAY MESSAGE	DESCRIPTION	DEFAULT/MIN /MAX VALUE
Max Frequency	Maximum frequency allowed. Parameter value cannot be set lower than MINIMUM FREQ.	60/5/300
Min Frequency	Minimum output frequency allowed except during startup ramp. When SUBMERSIBLE PUMP parameter is enabled, frequency will ramp from stop to minimum frequency in one second. Important in protecting thrust bearing in submersible pumps.	30/5/120
Startup Ramp Time	Time in seconds from MIN FREQUENCY to MAX FREQUENCY . Ramp speed is linear. In constant pressure, INTEGRAL GAIN will override this value. Increasing INTEGRAL GAIN will reduce error constant so ramp time is closer to STARTUP RAMP TIME value. Decreasing INTEGRAL GAIN will extend ramp time.	12/1/120
Shutdown Ramp Time	Time in seconds from MAX FREQUENCY to MIN FREQUENCY . Ramp time is linear. Factory default setting enables the COAST TO STOP parameter which disables the SHUTDOWN RAMP parameter.	5/1/120
Overcurrent Limit	Setting for motor overload protection, Trip Class 10 curve.	DXLL002: 9/3/11
		DXLL003: 11/3/13
		DXLL005: 18/3/22
Submersible Pump	ENABLE THIS FEATURE WITH SUBMERSIBLE PUMPS. Frequency will ramp from stop to the MIN FREQUENCY value in one second. Submersible pumps suffer damage to the thrust bearing if operated below 30 Hz for more than 1 second. YES = one second ramp time from stop to minimum frequency NO = linear ramp time from stop to maximum frequency. Minimum frequency is still observed while the motor is running.	Default: Yes
Dry Well Current	Drive faults when output current goes below the set value (dry well protection). Note: Fluctuating voltage can change motor currents without any change in power consumption.	DXLL002: 0/0/9
		DXLL003: 0/0/11
		DXLL005: 0/0/19
Switching Frequency	Switching frequency of the IGBT inverter module. Must be at or above 4 kHz if using a sine filter.	3k/2k/8k
Coast to Stop	Selects between coast to stop or ramp to stop. Ramp profile is controlled by parameter SHUTDOWN RAMP . NO = ramp to stop, YES = coast to stop	Default: Yes
GND Fault Detect Fault Sensitivity	Detects a fault between any output line and earth. Sensitivity to fault detection is adjustable to avoid nuisance trips. Parameter is disabled by default. Lower value equals lower sensitivity to fault detection.	Disabled/1/9

DISPLAY MESSAGE	DESCRIPTION	DEFAULT/MIN /MAX VALUE
PWM Over Modulation	PWM OVER MODULATION is added to increase the output voltage. If input voltage is below nominal 240 V, output voltage on voltage doubling drives could be low. Monitor output voltage and use this parameter to boost output voltage if necessary.	DXLL002: 0/0/25
		DXLL003: 0/0/25
		DXLL005: 0/0/25
V/f Selection	Controls the relationship between voltage and frequency when starting a motor for different applications. Standard: Voltage and frequency are proportional. Torque is constant. Soft Start: Limits voltage during initial ramp to reduce inrush current. Torque is reduced. Disable DC Bus Track: Disables output voltage modulation based on DC bus. May cause output current oscillation.	Default: Standard
Over Temp Derate Enable	Drive frequency will slow down to avoid motor overtemperature fault. Frequency will not go below MIN FREQUENCY . Screen will indicate OVERTEMP DERATE when conditions apply.	Default: Yes
Overcurrent Derate Enable	Drive frequency will slow down to avoid motor overcurrent fault. Frequency will not go below MIN FREQUENCY . Screen will indicate OVERCURRENT DERATE when conditions apply.	Default: Yes
Reverse Rotation	Reverses motor direction by changing sequence of output phase rotation.	Standard ABC / Reverse ACB
Minimum Derate Frequency	Output frequency will not go below this value when derating.	45/0/120
Max Cycle Time	The time period used to limit the maximum number of starts set by SHORT CYCLE STARTS .	0/0/1 hr 40 min
Startups Per Cycle	The maximum number of times the drive will start the load in the time period set by SHORT CYCLE TIMER .	60/0/9999

Table 11 - Auto Restart Parameters

DISPLAY MESSAGE	DESCRIPTION	DEFAULT/MIN /MAX VALUE
Enable Restarts	Controls the ability of the drive to automatically restart after a fault and to initialize in AUTO mode. NO = no auto restarts and unit will initialize in OFF mode YES = Auto mode on initialization and auto restarts allowed	Default: Yes
Dry Well Delay	Time in seconds dry well is allowed before unit trips	4/0/9999
Restart Delay 1	Delay in seconds before unit restarts after a trip due to: <ul style="list-style-type: none"> • MOTOR OVERLOAD 	60/0/9999
Restart Delay 2	Delay in seconds before unit restarts after a trip due to: <ul style="list-style-type: none"> • BUS OVERVOLTAGE • DRY WELL CURRENT • CURRENT UNBALANCE • 4-20mA • 15VDC POWER OVERLOAD 	15/0/9999
Restart Delay3	Delay in seconds before unit restarts after a trip due to: <ul style="list-style-type: none"> • HALL SENSE HIGH • LOW INPUT VOLT • HIGH INPUT VOLT 	15/0/9999
Restarts Motor Overload	Number of automatic restarts allowed due to motor overload current set by parameter OVERCURRENT LIMIT .	4/0/9999
Restarts Dry Well	Number of automatic restarts allowed due to under current trip	10/0/9999
Restarts Undervoltage	Number of automatic restarts allowed due to low input voltage trip	10/0/9999
Restarts Overvoltage	Number of automatic restarts allowed due to high input voltage trip	10/0/9999
Restarts Bus Overvoltage	Number of automatic restarts allowed due to DC bus overvoltage	10/0/9999
Start Up Delay	Delay in seconds before unit restarts after an input power cycle.	0/0/9999
Restarts Sensor Conn Fail	Number of automatic restarts allowed due to loss of 4-20mA analog input signal	10/0/9999
Short Cycle Delay	In seconds. Prevents the drive from engaging the motor when it is spooling down during coast-to-stop operation. Delay affects both manual RUN commands and RUN commands from external signals in auto mode. Display will count down seconds until RUN during delay.	3/0/300
Overload Derate Select	Changes the speed at which Max Frequency will decrease to prevent Overload faults.	Default: Medium Disabled Slow Fast

Note 1: The restart counter must be cleared to begin counting the number of restarts from zero. Main Menu item, Clear Memory, resets the fault counters. See **Section 3, Keypad Main Menu Items**, for more information.

Note 2: Push the up arrow key and down arrow key simultaneously to interrupt the countdown delay and allow an auto restart.

Table 12 - Interface Parameters

DISPLAY MESSAGE	DESCRIPTION	DEFAULT/MIN /MAX VALUE
System Config (see section 5.5 for detailed information)	Sets the system configuration. 0 = RUN/STOP control using AUX1 and AUX2. Both AUX1 and AUX2 must have a contact closure to run. By default, AUX1 and AUX2 are programmed to be always ON. See AUX1 SELECT and AUX2 SELECT to change this setting. 1 = Analog constant pressure control. 2 = Motor speed control proportional to 0-5VDC analog signal (speed potentiometer). 3 = Motor speed control proportional to 4-20mA analog signal. 4 = Analog constant pressure (4-20 mA only) with HOA switch and motor speed control by potentiometer.	0/0/4
Troubleshooting	Factory assisted use only. Contact manufacturer.	0/0/5
Password Setup	Allows keypad functionality to be password protected. When keypad is locked, parameters and values can be viewed but not changed. All zeroes disables password protection. Use arrows to scroll to a value that will become the password.	0000/0000/FFFF
Program Relay 1	Programmable normally open relay. Control terminals COM, 1NO. The relay can be programmed to change state for the following conditions: 0 = System Fault Open = normal, Closed = fault 1 = Reserved 2 = Reserved 3 = Reserved 4 = Pump Fault e.g. motor overload, dry well, etc. Open = normal operation, Closed = fault 5 = Minimum Frequency. Relay changes state when motor frequency is greater than the value set by parameter MIN FREQUENCY . (see Note 1) When lead/lag pump control has been selected, it will override programmable Relays 1, 2. 6 = Jockey Pump. Relay will not participate in lead/lag or multiplex pump control. Instead, relay will close when motor frequency is greater than 0, and open when it is exactly 0. This setting is only available for Relay 1.	0/0/6
Program Relay 2	Programmable normally open relay. Control terminals 2NO, 2C. See Parameter PROGRAM RELAY 1 above for description of values.	0/0/5
Analog In Reverse	Reverses the scale of the analog signal, both 0-5VDC and 4-20mA. For example, in normal 0-5VDC signal, 0V = low and 5V = high. In reverse, 5V = low and 0V = high. NO = normal, YES = reverse	Default: No
Disable Manual Mode	Disables manual operation of the drive through the keypad. Operating states are limited to AUTO and OFF. YES = MANUAL mode disabled	Default: Yes

DISPLAY MESSAGE	DESCRIPTION	DEFAULT/MIN /MAX VALUE
AUX1 Select	Programmable digital inputs. Generally used for motor Run/Stop control. 0= RUN/STOP (closed = RUN, open = STOP) 1= RUN/STOP (closed = STOP, open = RUN) 2= Always in RUN mode (no jumper or switch required)	1/0/2
AUX2 Select	Programmable digital inputs. Generally used for motor Run/Stop control. 0= RUN/STOP (closed = RUN, open = STOP) 1= RUN/STOP (closed = STOP, open = RUN) 2= Latching relay. When the connection between the AUX terminal and COM is opened the drive will stop the motor and display a fault on the screen. The motor will remain stopped even if the connection is closed. The fault must be cleared by pressing the ENTER key. 3= Reverse Rotation. When circuit opens motor will reverse. Function of these inputs can change when certain System Configuration settings are chosen. See Section 5.5, System Configuration , for additional info.	1/0/3
LCD Contrast	Used to adjust the contrast and readability of the graphic display.	40/30/63
Analog Select	Sets function and status of the 4-20 mA inputs, I_1 and I_2. 0 = I_1 ON 1 = I_2 ON 2 = I_1 ON, I_2 redundant 3 = I_2 ON, I_1 redundant	0/0/3

Note 1: This setting is typically used to control ancillary equipment in concert with motor RUN/STOP commands. For example, to control a chlorinator so that it operates only when the motor is pumping water.

Constant pressure parameters are only displayed when System Configuration has been set for constant pressure. **SYSTEM CONFIG** is found under Interface Parameters. See **Table 12** for details.

Table 13 - Constant Pressure Parameters

DISPLAY MESSAGE	DESCRIPTION	DEFAULT/MIN /MAX VALUE
T Off	In seconds. Used to prevent short cycling. If the motor was off during the last cycle for a period greater than T_{OFF} , the minimum on time of the motor is T_{1ON} . If the motor was off for a period less than T_{OFF} , the minimum on time of the motor is T_{2ON} . Default values give a minimum cycle time of about 1 minute.	30/0/1000
T1 On	In seconds. See T OFF above. T_{1ON} should be set less than T_{2ON} .	15/0/1000
T2 On	In seconds. See T OFF above. T_{1ON} should be set less than T_{2ON} .	60/0/1000
Shutoff Frequency	As Hz. This value is added to the frequency set by MINIMUM FREQ. The combined value is the frequency at which drive will enter sleep mode when pressure is controlled at the set point.	12/0/300

DISPLAY MESSAGE	DESCRIPTION	DEFAULT/MIN /MAX VALUE
Precharge Frequency	In Hz. Sets the frequency applied to the motor during the precharge interval.	30/1/120
Precharge Time	In minutes. Sets the maximum time for precharge regardless of any sensor inputs. A setting of zero disables the precharge mode.	0/0/30000
Boost Amount	As psi. The parameter value specifies a pressure increase in psi before sleep mode. The value is added to psi SETPOINT .	0/0/100
Broken Pipe psi	psi which will trigger fault after time duration set by BROKEN PIPE TIME. Value of zero disables this feature.	0/0/150
Broken Pipe Time	In minutes. Time at which unit will fault out if measured pressure is below BROKEN PIPE PSI.	0/0/9999
Precharge psi	Used only for analog CP systems. Precharge will be terminated when pressure reaches this value. Should be set less than psi SETPOINT .	20/0/200
Proportional Gain	Multiplier for the analog error signal in an analog CP system. When parameter is set to zero, the keypad displays SIMPLE MODE and the controller switches to an algorithm which does not require a gain setting. See Section 6.8, Troubleshooting Constant Pressure Systems , for details. When using PI control, best results will be obtained by starting with a value of 5 for PROPORTIONAL GAIN .	5/simple mode/60
Integral Gain	Multiplier for the integral term in PI control of analog CP. Used to fine tune pressure control. Parameter is disabled when PROPORTIONAL GAIN is set to SIMPLE MODE . See Section 6.8, Troubleshooting Constant Pressure Systems , for details.	12/0/100
Derivative Gain	Used to reduce overshoot and oscillation. Should be used only when necessary because it tends to amplify noise in the transducer signal. It may cause the system to become unstable.	0/0/50
PID Filter Gain	Controls the rate of frequency increase in response to the error term.	0/0/100
PID Filter Time	Sample interval for the PID Filter Gain.	1/0/10
Sleep psi (Overpressure)	This value is <u>added</u> to psi SETPOINT to set the pressure at which drive will stop the motor load. Motor will restart when the pressure falls to the value set by WAKE PSI .	20/0/500
4-20mA psi Sensor Range	As psi. This value should be set to the maximum psi of the 4-20 mA transducer being used i.e., if the transducer has a range of 0-150 psi the parameter should be set to 150. Critical for precise pressure control.	150/50/500
Wake psi (Drawdown)	As psi. Parameter controls the pressure drop below psi SETPOINT to start motor in sleep mode, e.g., if WAKE psi = 5 and motor turns off at 50 psi, motor will restart at 45 psi.	5/0/50
Duplex Cycle Time	In hours. Determines the run time for each cycle of both primary and secondary pump	0/0/9999
psi Setpoint	The pressure, in psi, the VFD will try to maintain. Must be set less than the range of the 4-20 mA transducer. SYSTEM CONFIG must be set for CP control. See Section 5.5, System Configuration , for details.	50/0/500
psi Offset	This is used to calibrate the pressure that the VFD registers from pressure transducer. For instance, if VFD reads 40 psi, but manual measurement shows 50 psi, this setting should be set to +10.	0/-50/+50

Lead/Lag parameters are only displayed when System Configuration has been set for constant pressure. More information on Lead/Lag can also be found in **Section 6.5, Lead/Lag Pump Control.**

Table 14 - Lead/Lag Parameters

DISPLAY MESSAGE	DESCRIPTION	DEFAULT/MIN /MAX VALUE
Number Lag Pumps	Number of auxiliary pumps connected to the relays on the control board. Relays are called in order, starting with Relay 1.	0/0/2
Stage Pump Delay	In seconds. Delay before the system will call for a pump to be staged in.	4/0/3600
De-stage Pump Delay	In seconds. Delay before the system will de-stage a pump when pressure is maintained at MIN FREQUENCY of the primary pump.	4/0/3600
Stage Frequency Reduction1	In Hz. Reduces frequency of primary pump for the duration of the STAGE TIME when the specified pump is staged in.	Lag #1: 5/0/120
Stage Frequency Reduction2		Lag #2: 5/0/120
Stage Time	In seconds. This is the interval for which the system will reduce its frequency by STAGE FREQ REDUCTION	4/0/3600
De-stage Freq Boost1	In Hz. Increases frequency of primary pump for the duration of the DESTAGE TIME when the specified pump is de-staged.	Lag #1: 5/0/200
De-stage Freq Boost2		Lag #2: 5/0/200
De-stage Time	In Seconds. This is the interval for which the system will increase its frequency by DESTAGE FREQ BOOST	4/0/3600
Stage psi Lag	In psi. Allows the system to fall below the control psi by this amount before the system starts counting STAGE TIME . Assumes max Hz.	5/0/200
De-stage psi Lag	In psi. Allows the system to exceed the control psi by this amount before the system starts counting DESTAGE TIME . Assumes min Hz.	3/0/200
De-stage Min Frequency	In Hz. MIN FREQUENCY of primary pump plus this amount to de-stage.	5/0/120
Precharge Pumps	Sets the number of auxiliary pumps that will assist the primary pump during a pre-charge interval. CAUTION! This number should never be greater that the total number of lag pumps as it will activate the associated programmable relay which may be used for other functions.	0/0/2

5 OPERATION

5.1 Commissioning the Unit

It is always advisable to check the operating status of the drive and its load before commencing regular operation.

Initial Operation

Verify the following:

1. The unit is securely attached to the proper mounting surface
2. The unit's input terminals are connected to an appropriate power source
3. An appropriately rated motor is connected to the output terminals
4. The motor is secured and properly mounted

Perfect Pressure™ Setup

Upon the first initialization of the unit (or after restoring factory defaults of all parameters using the Two Button Reset Procedure, page 17) the drive will prompt the user to select or decline a quick setup for constant pressure.

1. The display will read **SETUP CONST PRES YES (ENTER) / NO (HOME)**.
2. Press the ENTER key to set up Perfect Pressure™ or the HOME key to decline.

Basic parameters for analog constant pressure can be set without navigating through the complete menu options. Refer to **Section 6.2, Perfect Pressure™ Setup – Analog Constant Pressure**, for the information required to complete the setup, and have this information ready to enter when commissioning the unit.

5.2 Ground Fault Detection

DXLL drives are equipped with a feature to detect a fault between any of the output lines and earth. See **Table 10, Operating Parameters, GND FAULT DETECT**, for more information on using this parameter. If a ground fault is strong enough to trigger the parameter **GND FAULT DETECT**, the drive will not allow the IGBTs to switch. However, this does not protect the drive from damage in all situations. **If a ground fault occurs, immediately disconnect the input power!** Long motor leads can cause nuisance indications of a ground fault. If a megger does not indicate a ground fault, the sensitivity of the ground fault detection may need to be reduced by reducing the value of parameter **GND FAULT DETECT**.

 **CAUTION:** Before the motor is connected to the output terminals, check all output lines for line-to-ground faults using a megger. There is a direct path through the drive circuitry for ground fault currents that can be triggered when power is applied to the input terminals, even though the output switches are not activated. These currents can cause serious damage to drive circuitry and are not covered under warranty.

 **WARNING!** The default operating mode when the unit is energized is OFF. If the parameter **ENABLE RESTARTS** has been set to allow restarts, the unit will energize in AUTO mode. If the external controls are calling for a motor run condition, the motor will start. Make sure either external controls are off before

energizing the input, or as soon as the unit has initialized, push the STOP/OFF key until *OFF* appears on the display. Refer to **Section 3, Using the Keypad and Display**, for instructions on operating the keypad.

5.3 Drive Set-up Procedure

If remote or automatic ON/OFF function is required, connect remote switch leads to the AUX1 and COM terminals. An additional remote switch or jumper wire may be connected to the AUX2 and COM terminals.

 **CAUTION:** By default, AUX1 and AUX2 are programmed to be always in RUN mode. See parameters **AUX1 SELECT** and **AUX2 SELECT** to change this setting.

1. If a Constant Pressure (CP) water system will be operated, connect the pressure sensors to the appropriate control terminals. See **Section 5.5, System Configuration** and **Section 6, Constant Pressure Systems** for details.
2. Apply power to the input terminals of the drive by turning on the input circuit breaker or disconnect switch.
3. The graphic text display will scroll through several start-up sequence messages.
4. If the **ENABLE RESTARTS** parameter is set to allow restarts, the drive will initialize in AUTO mode and the motor will run when control signals call for a motor run condition. In order to prevent the motor from running at start-up, immediately after initialization, press the OFF/STOP key until OFF appears on the display or open AUX1 to COM or AUX2 to COM.
5. Confirm that the unit has properly energized, and the display indicates the OFF mode.
6. Using the keypad and display, navigate to the Main Menu item, **CHANGE PARAMETER VAULES**, to set the following parameters for basic operation (see **Table 10** through **Table 14** for details):
 - **INTERFACE PARAMETERS > SYSTEM CONFIG** This parameter is critical to the operation of the system. The default setting is for simple ON/OFF operation. See **Section 5.5, System Configuration**, for complete information.
 - **OPERATING PARAMETERS > OVERCURRENT LIMIT** This parameter sets the motor overload protection. See **Section 5.4, Motor Overload Protection** for complete information.
 - **AUTO RESTART PARAMETERS > ENABLE RESTARTS** This parameter enables the drive to initialize in AUTO mode and to restart automatically after a fault. Factory default does not allow auto restarts.
7. Push the MANUAL key until MANUAL appears in top left of the display for manual mode, then push RUN to start the motor. In manual mode, the RUN/AUTO key will override an open AUX terminal or other external control signal. Push the STOP/OFF key to stop the motor in manual mode.

 **CAUTION:** In manual mode, pushing the RUN key will override all external control signals, including constant pressure sensors. Be aware; **dangerous pressure rise in closed plumbing systems is possible when running in manual mode.**

8. The motor will start with the default acceleration ramp time of 0-30 Hz in one second, then 30-60 Hz in ten seconds.
9. Confirm that the motor rotation is correct. Swapping any two of the output leads or using the **REVERSE ROTATION** parameter will reverse the motor rotation.

10. After initial power-up, use the keypad and display to navigate to **CHANGE PARAMETER VALUES** to set any other adjustable parameters you wish to be different from the factory defaults.

5.4 Motor Overload Protection

SD drives are equipped with adjustable solid-state motor overload protection. Protection is based on a Class 10 trip curve. Motor overload settings are selected by navigating to the appropriate menu item using the keypad and display.

THERMAL MEMORY is the ability of an overload protective system to approximate the heating cooling of a protected motor during operation.

THERMAL MEMORY RETENTION maintains the thermal memory upon shutdown or power loss. This includes retention of the last thermal value and may include an ongoing reduction of this thermal value to reflect the cooling of the motor. This information will be used by the overload protective system to approximate the thermal state of the motor upon restart.

 **CAUTION:** Do not attempt to restart the motor immediately after a motor overload fault. The motor overload protection system uses a timer to approximate motor cooling and may trigger an immediate overload fault if the motor is restarted too soon.

Setting Motor Overload Protection with Keypad

To set motor overload protection with the keypad, navigate to the Main Menu item **CHANGE PARAMETER VALUES > CHANGE OPERATING PARAMETERS > OVERCURRENT LIMIT**. Refer to **Section 4.1, Changing Parameter Values, Table 10, Operating Parameters** for detailed instructions.

5.5 System Configuration

SD drives can operate several types of systems, including constant pressure water systems, with simple ON/OFF control from remote switches. **The correct system configuration must be selected for proper operation of different types of control systems.**

System configuration is set by navigating to the keypad Main Menu item **CHANGE PARAMETER VALUES > CHANGE INTERFACE PARAMETERS > SYSTEM CONFIG**. Refer to **Section 4.1, Changing Parameter Values**, and **Table 12** for detailed instructions. Below is a brief description of each configuration setting:

- **System Configuration = 0: Basic RUN/STOP operation.** This is the factory default configuration for basic operation of the drive that allows RUN/STOP control of the motor in AUTO mode using a dry contact on AUX1 and/or AUX2.

 **CAUTION: By default, AUX1 and AUX2 are programmed to be always in RUN mode.** See parameters **AUX1 SELECT** and **AUX2 SELECT** to change this setting.

System Configuration = 1: Analog Constant Pressure. Use this setting to operate analog constant pressure systems with a 4-20 mA transducer. Refer to **Section 6.3, Analog Constant Pressure Systems**, for more information on operating the drive in this mode. Refer to **Figure 5** for a diagram illustrating connection of the transducer to control terminals. If a redundant analog transducer is used, connect it to the I₂₊ and I₂₋ terminals in likewise fashion. If the sensor on I₁ fails (current signal is zero) the drive will look for a signal on I₂ to control pressure. If there is no signal on I₂ the drive will stop and indicate **SENSOR CONNECTION FAIL**.

System Configuration = 2: Speed control with 0-5VDC analog signal. Use this setting for motor speed control by a potentiometer connected to the 0-5 VDC control terminals. Refer to **Figure 5** for a diagram illustrating connection of the potentiometer to control terminals. The drive will ignore the analog signal until it reaches a value proportional to the speed set by the parameter, **MIN FREQUENCY**, which has a factory default setting of 30 Hz. For speed control across the full scale range of the analog signal, set **MIN FREQUENCY** to the minimum value of 5 Hz. AUX1 and AUX2 must be closed to run in this System Configuration.  **CAUTION: By default, AUX1 and AUX2 are programmed to be always ON.** See parameters **AUX1 SELECT** and **AUX2 SELECT** to change this setting.

System Configuration = 3: Speed control with 4-20 mA analog signal. Use this setting for motor speed control proportional to a 4-20 mA analog signal. The drive will ignore the analog signal until it reaches a value proportional to the speed set by the parameter, **MIN FREQUENCY**, which has a factory default setting of 30 Hz. For speed control across the full-scale range of the analog signal, set **MIN FREQUENCY** to the minimum value of 5 Hz. Refer to **Figure 6** for a diagram illustrating connection of the transducer to Control Terminals. When using an active powered 4-20 mA source, connect the leads to I_{1in+} and COM. AUX1 and AUX2 must be closed to run in this System Configuration.

 **CAUTION: By default, AUX1 and AUX2 are programmed to be always in RUN mode.** See parameters **AUX1 SELECT** and **AUX2 SELECT** to change this setting.

 **CAUTION:** This is not a CP control mode. Motor speed will be controlled in a linear fashion proportional to the analog signal.

The **SYSTEM CONFIG** must be in any of the CP modes to enable Precharge of the plumbing system or Lead/Lag pump control. See **Section 6.4, Precharge** and **Section 6.5, Lead/Lag Pump Control** for more information.

Start-Up and Shut-Down Ramp Times

Start-up and shut-down ramp times specify the time required to go from **MIN FREQUENCY** to **MAX FREQUENCY** or vice versa. Ramp times and profiles are adjustable using keypad navigation.

The factory default setting for **START UP RAMP** is 10 seconds and 4 seconds for **SHUTDOWN RAMP**. Factory settings activate the **COAST TO STOP** parameter to reduce nuisance tripping from high inertia loads. Coast to stop inactivates the **SHUTDOWN RAMP** parameter.

Submersible Pump Parameter and Minimum Frequency

Most submersible pump motor manufacturers require the motor to reach 30 Hz within one second in order to protect the pump from damage. Because the DXLL drives are frequently used for pumping applications, it has a parameter, **SUBMERSIBLE PUMP** that limits the time the motor runs below 30 Hz to one second.

When **SUBMERSIBLE PUMP** is set to YES, the motor speed will ramp to minimum frequency in one second, then ramp to the maximum frequency in a total of 10 seconds. The ramp times can be changed through the adjustable parameter, **START UP RAMP**. The factory default setting for **SUBMERSIBLE PUMP** is YES and **MIN FREQUENCY** is 30 Hz.

When the **SUBMERSIBLE PUMP** parameter is set to YES, the motor will ramp from stop to the maximum frequency in 10 seconds in a linear fashion as depicted in **Figure 9**.

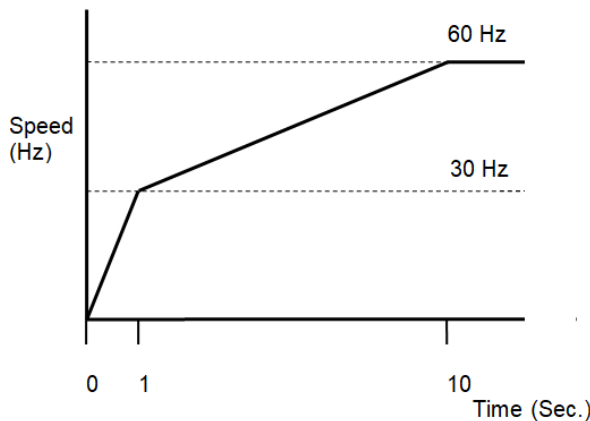

Figure 9 – Default Start-Up Ramp (SUBMERSIBLE PUMP parameter enabled)

To set the minimum frequency, navigate to the keypad Main Menu item: **CHANGE PARAMETER VALUES > CHANGE OPERATING PARAMETERS > MIN FREQUENCY > 30 Hz**. When **SUBMERSIBLE PUMP** is set to NO ramp times will be linear, as depicted in **Figure 10**.

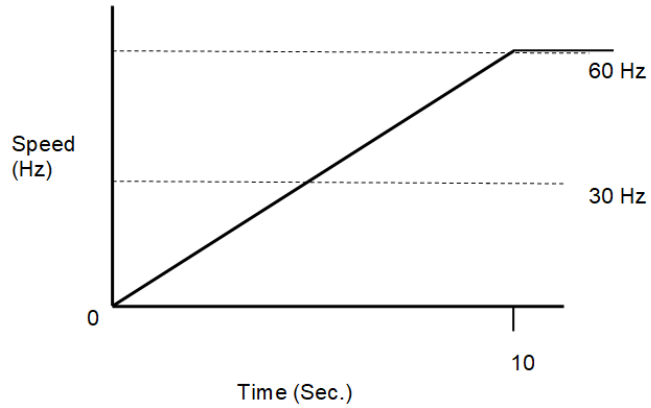

Figure 10 – Start-Up Ramp (SUBMERSIBLE PUMP parameter disabled)

⚠ CAUTION: Most submersible pump motor manufacturers require the motor to reach 30 Hz within one second in order to protect the pump from damage. Factory default ramp time is 0-30 Hz in one second, followed by the selected ramp time from 30 Hz to maximum frequency.

6 CONSTANT PRESSURE SYSTEMS

SD drives can be configured as constant pressure (CP) water systems to maintain a constant pressure under variable flow conditions. A CP water system includes a pressure tank, a pressure gauge to observe system pressure, and a 4-20 mA analog pressure sensor.

6.1 Control Principles of Constant Pressure Systems

In a CP system, a target pressure for the system is set through the keypad. A signal from the pressure sensor interacts with firmware in the drive controller to control the motor speed and maintain a constant water pressure.

In a strict definition of a constant pressure system, the pump would never turn off. If the pressure differential between pump-on and pump-off was actually zero, the noise fluctuations of the sensor output would cause the motor to cycle constantly between the on and off states. For this reason, most applications will want to accept a small differential pressure in the system to prevent either continuous running of the motor, or constant on/off cycling of the motor.

Three basic conditions must be met for the pump to shut down and enter sleep mode:

1. The pressure in the system must be at the pressure control point set by the parameter **psi SETPOINT**.
2. The pump speed has slowed to a frequency below the value determined by **SHUTOFF FREQ + MIN FREQ**. For example, if **SHUTOFF FREQ** is 10 and **MIN FREQ** is 30, the pump will enter sleep mode at 40 Hz.
3. The time expired since the pump started after the last OFF cycle must be greater than parameter **T1ON** or **T2ON**.

If the system pressure goes above the parameter **SLEEP psi** the pump will immediately shut down. **SLEEP psi** is equal to **psi SETPOINT** plus **SLEEP psi**. For example, if **psi SETPOINT** is 50 and **SLEEP psi** is 20 the pump will shut down at 70 psi.

Disable Sleep Mode

In some applications the user may choose to prevent the pump from entering sleep mode. This is accomplished by setting the parameter **SHUTOFF FREQUENCY** to a value of zero. In low or no flow conditions the pump will slow to the speed determined by **MIN FREQUENCY** and remain at that speed indefinitely.

 **CAUTION:** When sleep mode is disabled in low flow conditions, the drive will slow down to minimum frequency and continue to run. Inadequate water flow in this condition may overheat and damage the pump.

Preventing Short Cycling During Low Flow Conditions

When a CP system is in a low flow state, it may be desirable to turn the motor off (sleep mode) in order to conserve energy and preserve the motor. The adjustable parameters **TOFF**, **T1ON**, **T2ON**, **SHUTOFF FREQUENCY**, **SLEEP psi**, **WAKE PSI**, and **BOOST AMOUNT** control when the motor is

turned off, how long it is off, and prevent short cycling of the motor at low water flow rates. More information including default values for these parameters can be found in **Table 13**. Constant Pressure parameters are only displayed when System Configuration has been set for Constant Pressure. **SYSTEM CONFIG** is found under Interface Parameters. See **Table 12** for details.

WAKE PSI and BOOST AMOUNT

The primary method of preventing short cycling is to allow a differential between the pressure at which the pump turns off to enter sleep mode and the pressure at which it restarts. Two parameters, **WAKE PSI** and **BOOST AMOUNT**, control this differential. **BOOST AMOUNT** specifies the increase in pressure above **psi SETPOINT** just before the pump shuts down to enter sleep mode, while **WAKE PSI** specifies the pressure drop below **psi SETPOINT** at which the pump restarts. For example, assume **psi SETPOINT** = 50, **BOOST AMOUNT** = 5, and **WAKE PSI** = 5. When the pump is ready to enter sleep mode, the pump will boost to 55 psi, then restart when the pressure falls to 45 psi. These two parameters can be used together or independently to create a dead band in pressure control.

Both **SLEEP PSI** and **SHUTOFF FREQUENCY** cause the drive to enter sleep mode. **SLEEP psi** is additional system protection. It is a value that is added to the **psi SETPOINT**. The default value for **SLEEP psi** is 20. For example, if the **psi SETPOINT** is 50 psi, the drive will stop the motor if pressure reaches 70 psi.

The parameter **SHUTOFF FREQUENCY** is used to put the drive in sleep mode when pressure is controlled and flow is low. Shut off frequency is a value that is added to **MIN FREQUENCY**. For example, if minimum frequency is 30 Hz and shut off frequency is 12, the drive will enter sleep mode at 42 Hz. When a value of zero is entered for the parameter **SHUTOFF FREQUENCY**, sleep mode is disabled.

 **CAUTION:** When sleep mode is disabled in low flow conditions, the drive will slow down to minimum frequency and continue to run. Inadequate water flow in this condition may overheat and damage the pump.

ON/OFF Cycle Timers

The drive records the length of time the motor remained in the OFF cycle and compares that time to the parameter, **TOFF**. If the motor-off time during the last OFF cycle was greater than the value of **TOFF**, then the minimum motor-on time will be equal to **T1ON**. If the motor-off time was less than **TOFF**, the minimum motor-on time will be equal to **T2ON**.

In other words, the time of the last OFF cycle determines whether the next ON cycle should be relatively long or relatively short. The graphic in **Figure 11** demonstrates how the system adjusts the motor-on time in response to motor-off time.

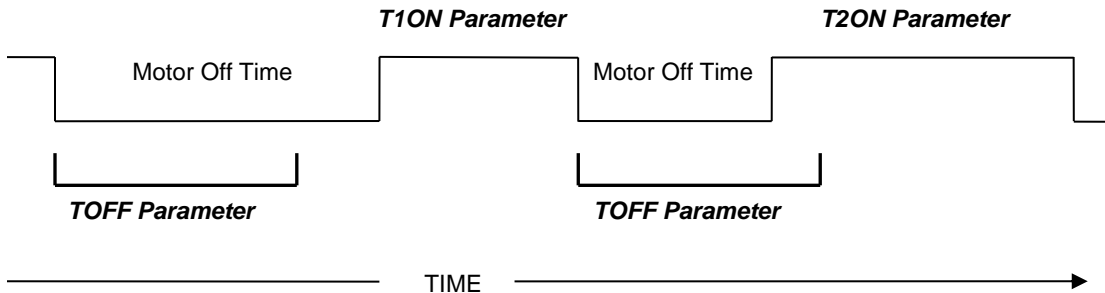

Figure 11 – Motor On and Motor Off Times

Fine Tuning With PI Control

When operating in constant pressure mode, if the parameter **PROPORTIONAL GAIN** is set to a value less than 1, the keypad displays **SIMPLE MODE** and the controller uses an algorithm that is not PI control. Simple Mode requires less fine tuning than PI control, but in some applications may not provide the control and stability desired. The stability of the constant pressure system (i.e., its tendency **not** to exhibit pressure oscillations) is determined by parameters set on the keypad, the flow rate of the pump, and the volume of the pressure tank. Stability of a system with a large maximum flow rate and a small pressure tank will be more difficult to control and may require de-tuning the system to accept larger variations in the system pressure and longer response times. Analog CP systems with PI (proportional integral) control provide more options to fine tune pressure control than Simple Mode. Systems that are not adequately controlled with the Simple Mode may require fine tuning by switching to PI control. Increasing the value of **PROPORTIONAL GAIN** to any value greater than **SIMPLE MODE** will initiate PI control. Pressure control is achieved by adjusting the values of **PROPORTIONAL GAIN** and **INTEGRAL GAIN**. Larger values for **PROPORTIONAL GAIN** and **INTEGRAL GAIN** give smaller errors in the pressure, but also make the system more susceptible to oscillation.

Emergency Over-Pressure Limit Switch

CP systems have the option of connecting an emergency over-pressure limit switch to the AUX2 terminals in case the main pressure control system fails. The emergency over-pressure set-point should be at least 10 psi higher than the system control pressure to prevent nuisance tripping.



CAUTION: By default, AUX1 and AUX2 are programmed to be always in RUN mode. See parameters **AUX1 SELECT** and **AUX2 SELECT** to change this setting.

SIMPLE MODE Control

When the **PROPORTIONAL GAIN** parameter is set at the lowest value, the display will read "**SIMPLE MODE**". In **SIMPLE MODE** a set of control equations is used which may not require the user to tune the system to obtain acceptable performance.

A well-tuned PI controller will result in smoother pressure control but may not be required. When the controller is in simple mode the only parameters which affect the pressure control loop are the **psi SETPOINT**, **STARTUP RAMP**, **SHUTDOWN RAMP** and **BOOST AMOUNT**, which function in the same way as they do in the PI control mode. Adjusting ramp times may smooth out any oscillation or overshoot in simple mode. If pressure is not adequately controlled, switch to PI control by increasing parameter **PROPORTIONAL GAIN**.

Using PI Control in Constant Pressure

When using an analog pressure transducer for control in CP water systems, it may be desirable to use a proportional-integral (PI) controller in the feedback loop. This type of controller has a proportional gain and integral gain which can be tuned by the user to obtain optimum performance for each particular application. Increase parameter **PROPORTIONAL GAIN** to switch control from Simple Mode to PI control. It is recommended to start with a parameter value of 5. A proportional gain value too low will result in slow response time to reach the **psi SETPOINT**. A value too high will result in overshoot of the **psi SETPOINT** and may create excessive oscillation of pressure.

First, attempt to control pressure by adjusting parameter **PROPORTIONAL GAIN**, leaving parameter **INTEGRAL GAIN** at the default value of 15. If adequate control cannot be obtained by adjusting proportional gain, set proportional gain at the value that gives the best control, and then adjust integral gain to improve pressure control.

For difficult to control systems, a derivative term can be introduced for PID control, which can help control pressure oscillation and overshoot. Increase the value of parameter **DERIVATIVE GAIN** to a value greater than zero to enable PID control. This parameter should be used only when necessary as it tends to amplify noise in the transducer signal. The system may become unstable. The parameters **PID FILTER GAIN** and **PID FILTER TIME** help to prevent overshoot. It may be advisable to contact the factory for assistance when using PID control for the first time.

In conceptual terms, proportional gain affects how quickly the system responds to pressure changes and integral gain affects the accuracy of pressure tracking. Adjusting ramp times can also be considered. Increasing ramp time will damp response to pressure changes, while decreasing ramp time will quicken the response.



CAUTION: Long ramp times can interfere with PI control of constant pressure. It is advisable to start with factory default ramp times.

Pressure Control at Minimum Speed

There is a possibility of conflict between the minimum pump speed setting, controlled by the parameter **MIN FREQUENCY**, and the pressure setting of the transducer. That is, if under no-flow conditions the pump at its minimum speed setting produces a pressure greater than the desired set-point, either the minimum speed will have to be reduced (not an option with submersible pumps) or the pressure set-point will have to be increased. Most pumps should not produce enough pressure head at 30Hz for this to be an issue.

Boost in a Digital Constant Pressure System

In a digital CP system the drive can only determine the pressure of the system at the set-point. Based on the characteristics of the on/off signals from the switch, which occur at the set-point, it maintains pressure. The parameter **BOOST AMOUNT** in a digital system is a percent increase in speed, not in pressure, because the digital switch cannot determine a pressure beyond its set-point.

In an analog system the **BOOST AMOUNT** is a specified psi, so the user can accurately control the boost pressure through the parameter setting on the keypad. For example, if boost of 5 psi above control pressure is desired, simply set parameter **BOOST AMOUNT** to 5.

In a digital system **BOOST AMOUNT** is an increase in speed for a given time as a percent of the speed the pump was running when the switch last opened at the set-point. For example, if pressure is controlled at a speed of 30 Hz, a **BOOST AMOUNT** value of 10 would be 10% of 30 Hz or 3 Hz. In low flow systems where the pressure is controlled at low speed, the **BOOST AMOUNT** value may need to be significantly higher than it would be set in an analog system under the same conditions.

6.2 Perfect Pressure™ Setup – Analog Constant Pressure

Upon the first initialization of the unit (or after restoring factory defaults of all parameters using the Two Button Reset Procedure, on page 17) the drive will prompt the user to select or decline a quick setup for constant pressure. The display will read **SETUP CONST PRES YES(ENTER)/NO(HOME)**. Press the ENTER key to set up Perfect Pressure™ or the HOME key to decline. Basic parameters for analog constant pressure can be set without navigating through the complete menu options.

Follow this procedure to set up Perfect Pressure™:

1. **SETUP CONST PRES YES(ENTER)/NO(HOME)** - Press the ENTER key to proceed.
2. **psi SETPOINT** - This value determines the pressure you want to maintain. The factory default is 50 psi. Use the arrow keys to change if desired. Press ENTER to proceed.
3. **SUBMERSIBLE PUMP** - This parameter sets the ramp profile for a submersible pump. **YES = submersible pump, NO = vertical pump**. For submersible pumps the frequency accelerates from 0-30 Hz in one second, then follows the ramp time from 30 Hz to maximum frequency. If NO is selected the frequency will increase in a linear fashion from zero to max frequency.
4. **OVERCURRENT LIMIT** – Setting for motor overload protection (service factor amp rating for the motor).

 **CAUTION:** Most submersible pump motor manufacturers require the motor to reach 30 Hz within one second in order to protect the pump from damage. Selecting NO for the parameter above will override the factory default ramp time of 0-30 Hz in one second.

This quick setup of constant pressure should provide good pressure control in most situations. It is advisable to read the entire section on constant pressure control for a complete explanation of constant pressure control methods. Constant pressure parameters are only displayed when System Configuration has been set for Constant Pressure. **SYSTEM CONFIG** is found under Interface Parameters. See **Table 12** for details.

6.3 Analog Constant Pressure Systems

The analog CP system uses an analog pressure transducer connected to the analog input (I1+ and I1- or I2+ and I2-) on the control terminals (see **Figure 7** for one-line and wiring diagrams). A normally-closed emergency over-pressure switch connected to the AUX2 terminals is also recommended. These are used in conjunction with the internal firmware of the drive to implement a constant pressure water system.

The drive uses a proportional-integral (PI) or proportional-integral-derivative (PID) controller in the feedback loop for constant pressure control. This type of controller has a gain adjustment which must be tuned by the user to obtain optimum performance for each particular application. Phase Technologies has also developed a proprietary controller, Simple Mode, which requires minimal tuning. When the **PROPORTIONAL GAIN** parameter is set at the lowest value, the display will read "**SIMPLE MODE**".

In Simple Mode a set of control equations is used which usually requires minimal tuning of the system to obtain acceptable performance. A well-tuned PI or PID controller will give smoother pressure control and may be necessary to control unstable systems. When the controller is in Simple Mode, the only parameters which affect the pressure control loop are **psi SETPOINT**, **STARTUP RAMP**, **SHUTDOWN RAMP** and **BOOST AMOUNT**.

In PI control mode the analog signal from the pressure transducer is compared to the parameter **psi SETPOINT**, which controls the motor speed to maintain constant pressure in the system. In this control scheme, the error signal between the pressure transducer and the internal signal determined by the **psi SETPOINT** value is multiplied by the **PROPORTIONAL GAIN**. This signal is then used to determine the motor frequency. If the pressure transducer signal and the internal set-point value were the same, then the motor speed would be zero. High **PROPORTIONAL GAIN** and **INTEGRAL GAIN** values give smaller error in the pressure, but also make the system more susceptible to oscillation.

Additional adjustable parameters found in the Constant Pressure menu help to optimize the performance of the system. The use of these parameters was discussed in the previous section. The unit is shipped with default settings which will work in many applications with no adjustment. As with all systems of this type there are tradeoffs between maintaining a tightly controlled set-point, achieving high motor efficiency, and maintaining system stability.

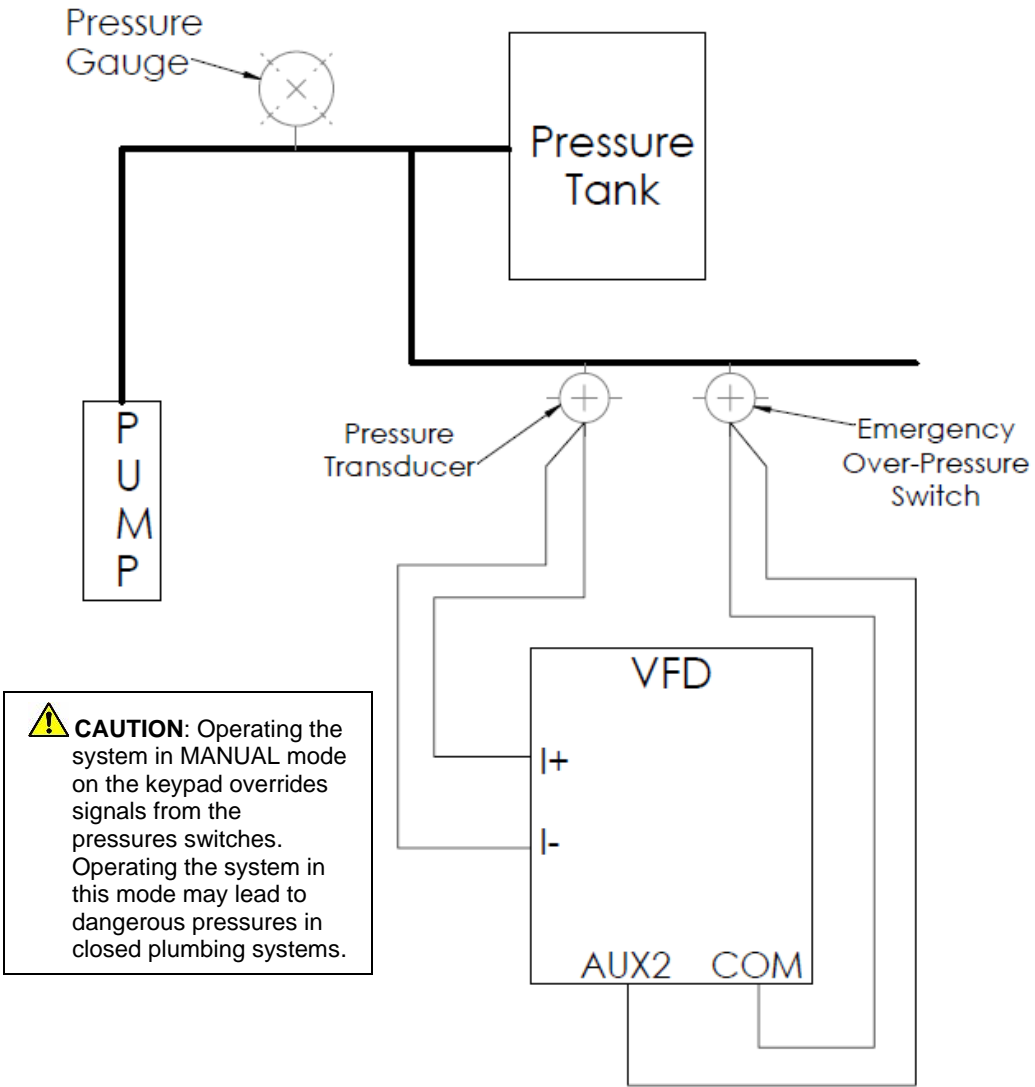

Figure 12 – Analog Constant Pressure Diagram

Basic Analog Constant Pressure Installation Procedures:

1. Install the analog pressure transducer and emergency over-pressure switch in the water line



Control Tip: Turbulence near pressure transducer can result in poor pressure control. For best results, pressure transducers should be placed at least 6 inches away from pressure tanks, check valves, and pipe elbows.

2. Remove protective rubber boot from the over-pressure switch, insert factory provided duplex cable through the boot, and connect a twisted pair of wires to the normally closed (NC) and common (C) terminals of the switch



CAUTION: The use of shielded cable is recommended. Regular wire may induce capacitance in the line and corrupt the signals from the pressure switches.

3. Attach the cable shield to the control terminal ground post located in the drive enclosure adjacent to the control terminals
4. Connect the emergency over-pressure limit switch to the AUX2 control terminal and COM (common).



CAUTION: By default, AUX1 and AUX2 are programmed to be always in RUN mode. See parameters AUX1 SELECT and AUX2 SELECT to change this setting.

5. Navigate through the keypad Main Menu item **CHANGE PARAMETER VALUES > INTERFACE PARAMETERS > SYSTEM CONFIG**. Select **1** to set the system configuration for an analog CP system (see **Table 12**). Constant pressure parameters are only displayed when System Configuration has been set for constant pressure. **SYSTEM CONFIG** is found under Interface Parameters. See **Table 12** for details.
6. To set the emergency over-pressure limit switch, remove the rubber boot from the switch and pry the plastic plug from the top of the switch housing to access the pressure adjustment screw. Use an Allen wrench to adjust the pressure setting of the switch and run the pump in the AUTO mode, and observe the pressure gauge, turning the Allen screw to adjust the pressure shut-off point. **The emergency over-pressure limit switch should be set at least 10 PSI higher than the desired constant pressure set point.**
7. Connect the remaining twisted pair of wires to the + and – terminals of the transducer
8. Connect the positive terminal of the transducer to the I_1+ control terminal, and the negative terminal to the I_1- control terminal.
9. If a redundant analog transducer is used, connect it to the I_2+ and I_2- terminals. If the sensor on I_1 fails (current signal is zero) the drive will look for a signal on I_2 to control pressure. If there is no signal on I_2 the drive will stop and indicate **ANALOG 20 mA FAULT**.



CAUTION: It is critical that the positive terminal of the transducer is connected to the + terminal of the 4-20mA Control Terminal, and likewise for the negative terminals.

10. Set the **psi SETPOINT** on the keypad (see for details)
11. Set the keypad to AUTO mode to operate the system

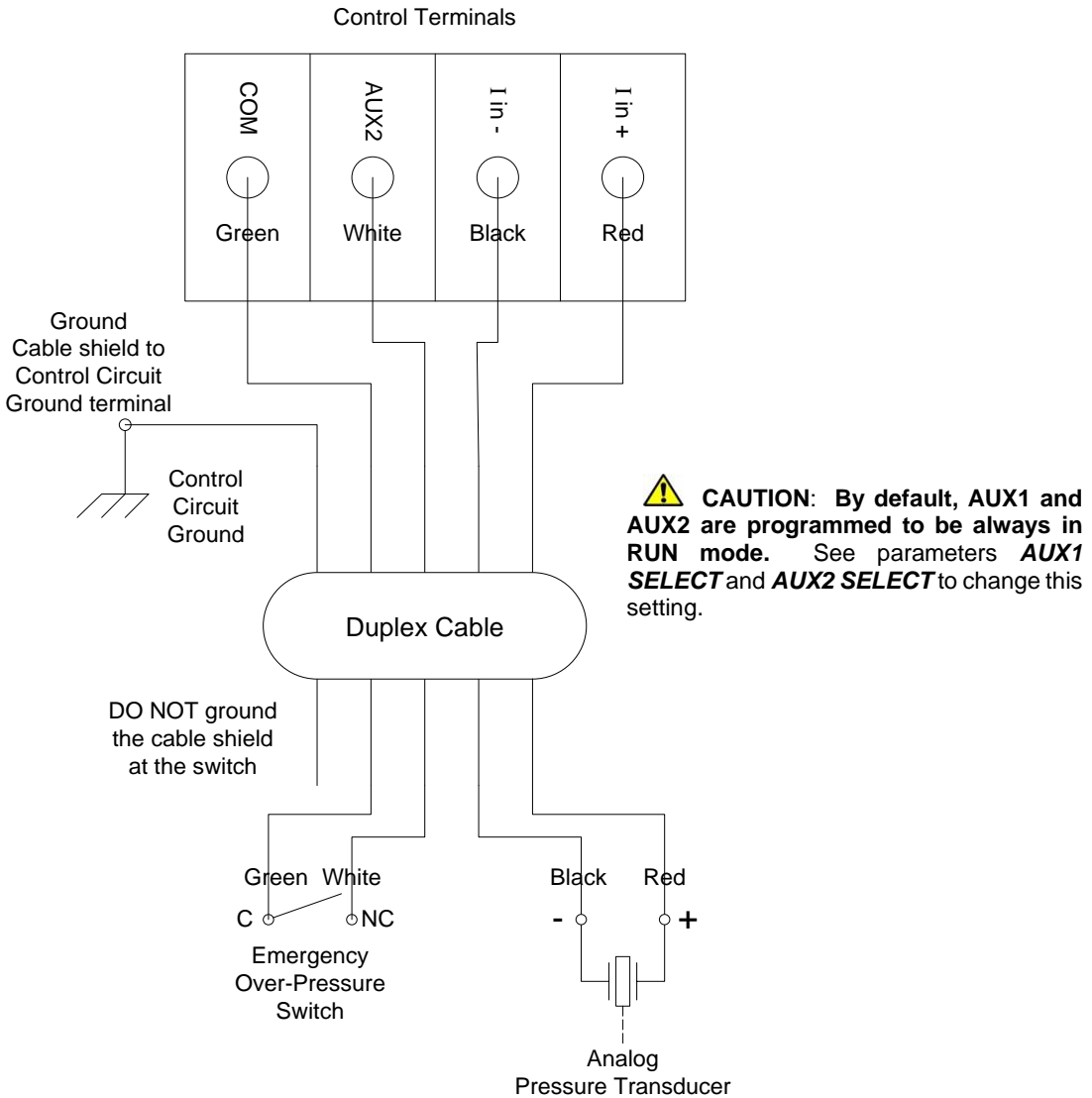

Figure 13 – Analog Constant Pressure System Schematic

The analog CP system uses an analog pressure transducer connected to the analog input on the control terminals (see **Figure 7** for one-line and wiring diagrams). A normally-closed emergency over-pressure switch connected to the AUX2 terminals is also recommended. These are used in conjunction with the internal firmware of the drive to implement a CP water system.

When using an analog pressure transducer for control in CP systems, it is very common for the system controller to use a proportional-integral (PI) or proportional-integral-derivative (PID) controller in the feedback loop. This type of controller has a gain adjustment which must be tuned by the user to obtain optimum performance for each application. Phase Technologies has also developed a proprietary controller, **SIMPLE MODE**, which requires minimal tuning. When the **PROPORTIONAL GAIN** parameter is set at the lowest value, the display will read "**SIMPLE MODE**".

In **SIMPLE MODE** a set of control equations is used which usually requires minimal tuning of the system to obtain acceptable performance. A well-tuned PI or PID controller will give smoother pressure control and may be necessary to control unstable systems. When the controller is in **SIMPLE MODE**, the only parameters which affect the pressure control loop are **psi SETPOINT**, **STARTUP RAMP**, **SHUTDOWN RAMP** and **BOOST AMOUNT**.

In PI control mode the analog signal from the pressure transducer is compared to the parameter **psi SETPOINT**, which controls the motor speed to maintain CP in the system. In this control scheme, the error signal between the pressure transducer and the internal signal determined by the **psi SETPOINT** value is multiplied by the **PROPORTIONAL GAIN**. This signal is then used to determine the motor frequency. If the pressure transducer signal and the internal set-point value were the same, then the motor speed would be zero. High **PROPORTIONAL GAIN** and **INTEGRAL GAIN** values give smaller error in the pressure, but also make the system more susceptible to oscillation.

Additional adjustable parameters found in the **CONSTANT PRESSURE** menu help to optimize the performance of the system. The use of these parameters was discussed in the previous section. The unit is shipped with default settings which will work in many applications with no adjustment. As with all systems of this type there are tradeoffs between maintaining a tightly controlled set-point, achieving high motor efficiency, and maintaining system stability.

6.4 Precharge Mode

When filling a large plumbing system with water, it may be desirable to fill at a slow pump speed so that when the system reaches the full point, water hammer does not cause damage such as sprinkler head blow-off or burst pipes. To achieve this, the drive is equipped with a precharge feature.

This feature is disabled if the **PRECHARGE TIME** parameter is set to zero. The frequency of the pump will not exceed the value set by the **PRECHARGE FREQ** parameter during the precharge interval.

The precharge interval will terminate when the system pressure exceeds the setting of the **PRECHRG psi** parameter. In this case, the **PRECHRG psi** must be lower than the **psi SETPOINT**.

The precharge interval occurs whenever the drive is switched from OFF to AUTO or MANUAL > RUN.

Precharge Mode Setup:

1. Navigate through the keypad menu to:
CHANGE PARAMETER VALUES > CONSTANT PRESSURE PARAMETERS > PRECHARGE FREQ
Enter the Precharge frequency
2. Navigate through the keypad menu to:
CHANGE PARAMETER VALUES > CONSTANT PRESSURE PARAMETERS > PRECHARGE TIME.
Enter the Precharge time in minutes
3. Navigate through the keypad menu to:
CHANGE PARAMETER VALUES > CONSTANT PRESSURE PARAMETERS > PRECHRG psi.
Enter the precharge pressure in psi.
This value must be lower than the **psi SETPOINT**
4. Set the keypad to AUTO mode to operate the system

6.5 Lead/Lag Pump Control

When any analog CP system configuration is selected, the LEAD/LAG menu is available. See **Table 14**, Lead/Lag Parameters, for lead/lag control options. Up to two additional pumps can be controlled through programmable relays on the main control printed circuit board. When the parameter **NUMBER LAG PUMPS** is greater than 0, both relays will convert to control of lead/lag constant pressure.

 **CAUTION:** Activation of lead/lag control overrides the function of all programmable relays. Any function of these relays, set up through the Interface Parameters, will be disabled.

Lead/lag control in pumping systems is a common practice to maintain pressure with highly variable flow. The system is typically configured with a main pump controlled by a VFD operating in CP mode, and with auxiliary pumps that are controlled by the drive. The auxiliary pumps typically operate across-the-line at 60 Hz. They may be equipped with a soft starter to mitigate inrush currents.

If the main pump cannot maintain system pressure it will call for an auxiliary pump by closing a relay on the control terminals. DXLL drives can control up to two auxiliary pumps. There are features to reduce oscillations and ensure smooth staging and de-staging pumps.

Lead/Lag Set-up

System Configuration must be set to one of the constant pressure modes when using lead/lag control. See **Section 5.5** for details. Lead/lag control is enabled when the number of lag pumps is set to a value greater than zero in the parameter **NUMBER LAG PUMPS**.

Lead/Lag Programming Steps:

1. Use the keypad to navigate to the Main Menu item, **CHANGE PARAMETER VALUES**, then to sub-menu **LEAD LAG PUMP PARAMETERS**. Scroll through parameters to find **NUMBER LAG PUMPS** and use the arrow keys to set the number of auxiliary pumps in the system.
2. If necessary, adjust the remaining Lead/Lag parameters after reading the following description of their functions, or after operating conditions dictate.

Lag pumps are turned on and off, or “staged” and “de-staged”, by programmable relays accessed through the control terminals. The drive calls for lag pumps in ascending order, beginning with Relay 1. See **Figure 14**, *Programmable Relays for Lead/Lag Control*, to locate the relays. **Figure 15**, *Lead/Lag Schematic*, provides a wiring diagram.

Lead/lag parameters (See **Table 14**) are used to smoothly stage the pumps in and out, mitigating pressure oscillation, short-cycling, and water hammer. When the main pump cannot maintain pressure, the drive will stage in an auxiliary pump. The drive will de-stage the pump when flow increases pressure beyond the control point.

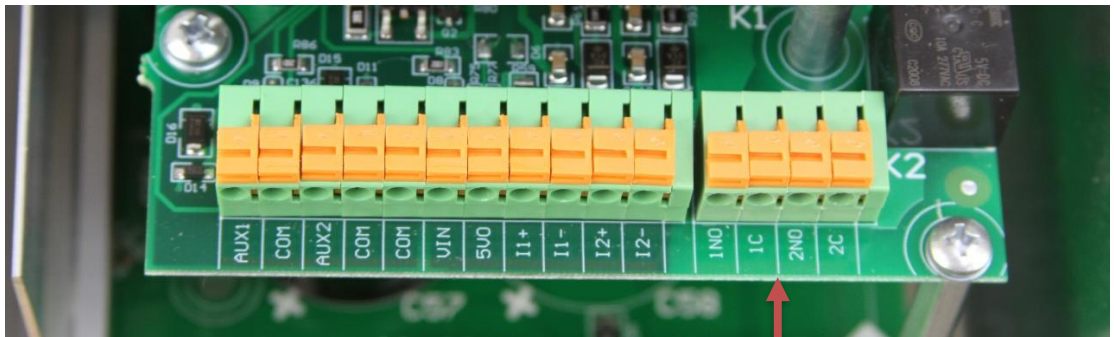

Programmable relays 1NO, 2NO.

⚠ CAUTION:

See **Table 5** for relay ratings. Direct control of the coil on a magnetic motor starter will likely cause damage to the relay and the main control printed circuit board. Use of a secondary control relay, such as an ice cube relay, may be necessary to control the lag pump motor starter.

Figure 14 – Programmable Relays for Lead/Lag Control

Two conditions must be met to stage a pump:

1. The system psi has decreased to a pressure equal to **psi SETPOINT** minus **STAGE PSI LAG**. For example, if the **psi SETPOINT** is 50 psi and you want to stage a pump in at 45 psi, **STAGE PSI LAG** should be set to a 5.
2. The time set by **STAGE PUMP DELAY** has expired. This delay allows momentary drop in system pressure without calling for a pump to stage in.

Pumps are staged in the following sequence:

1. The relay will close to start the stage pump.
2. The speed of the main pump will decrease to a value equal to **MAX FREQUENCY** minus **STAGE FREQUENCY REDUCTION**. For example, if **MAX FREQUENCY** is 60 Hz and **STAGE FREQUENCY REDUCTION** is 5 Hz, the pump speed will be reduced to 55 Hz.
3. The main pump will operate at reduced speed for a period of time set by **STAGE TIME**.
4. When **STAGE TIME** has expired the system will resume normal constant pressure control.

Pumps are de-staged when the drive has slowed the main pump to maintain control pressure and the auxiliary pump(s) causes a rise in pressure.

Three conditions must be met to de-stage a pump:

1. The system psi has increased to the value set by **DESTAGE PSI LAG** above **psi SETPOINT**. For example, if **psi SETPOINT** is 50 and **DESTAGE PSI LAG** is 5 the pump will de-stage at 55 psi.
2. The time set by **DESTAGE PUMP DELAY** has expired. This delay prevents de-staging the auxiliary pump due to momentary pressure overshoot.
3. The drive frequency to the main pump is between **MIN FREQUENCY** and the value of **DESTAGE MIN FREQUENCY** plus **MIN FREQUENCY**. For example, if **MIN FREQUENCY** is 30 Hz and **DESTAGE MIN FREQUENCY** is 5 Hz, the pump will de-stage at 35 Hz.

Pumps are de-staged in the following sequence:

1. The relay will open to de-stage the pump.
2. The speed of the main pump will increase to a value equal to **MIN FREQUENCY** plus **DESTAGE FREQ BOOST**. For example, if **MIN FREQUENCY** is 30 Hz and **DESTAGE FREQ BOOST** is 5 Hz, the pump speed will be increased to 35 Hz.
3. The main pump will operate at increased speed for a period of time set by **DESTAGE TIME**.
4. When **DESTAGE TIME** has expired the system will resume normal constant pressure control.

Control Terminals

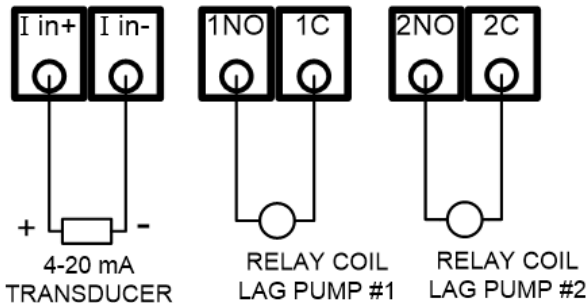

CAUTION: The relays are rated 0-30 VDC or 230 VAC, 10 Amp. Direct control of the coil on a magnetic motor starter will likely cause damage to the relay and the main control printed circuit board. Use a secondary control relay, such as an ice cube relay, may be necessary to control the lag pump motor starter.

Use the relays in order, beginning with Relay 1.

Figure 15 - Lead/Lag Schematic

6.6 Duplex / Multiplex Control

When any analog CP system configuration is selected, the **CONSTANT PRESSURE** and **LEAD/LAG** menus are available. Up to two additional VFDs can be controlled through the relays. When the parameter **NUMBER LAG PUMPS** is greater than 0, all two relays will convert to control of lead/lag or duplex/multiplex constant pressure. In addition, the parameter **DUPLEX CYCLE TIME** must be greater than 0 for Multiplex control to be active.

When operating in Multiplex Control, the main VFD will assume the role of Master, and all auxiliary VFDs controlled through the relays are known as Slaves. **The Master and Slave VFDs will operate in constant pressure mode.**

If the Master VFD senses that system pressure cannot be maintained, it will call for a Slave VFD by closing a relay on the control terminal. [DXLL Series drives can control up to two auxiliary VFDs.](#)

In Multiplex control, the Master VFD might not always be the drive that is operating. The point of a multiplex system is to rotate the use of each available VFD. This is done so that a single drive or pump does not degrade at a faster rate than other drives or pumps in that system. The Master VFD will decide when to stage or de-stage a VFD. The first pump to be staged in, and the last pump to be de-staged, is called the Primary VFD.

Multiplex Setup

System configuration must be set to one of the CP modes when using multiplex control. See **Section 5.5, System Configuration** for details. Multiplex control is enabled when **NUMBER LAG PUMPS** is greater than 0, and **DUPLEX CYCLE TIME** is greater than 0.

Multiplex Programming Steps:

1. Use the keypad to navigate to the Main Menu item, **CHANGE PARAMETER VALUES**, then to sub-menu **LEAD LAG PUMP PARAMETERS**. Find the parameter **NUMBER LAG PUMPS** and use the arrow keys to set the number of auxiliary drives in the system.
2. Navigate to **CONSTANT PRESSURE PARAMETERS** and find the parameter **DUPLEX CYCLE TIME** and use the arrow keys to set how often the Primary drive position will change.
3. If necessary, adjust the remaining Lead/Lag parameters after reading the following description of their functions, or after operating conditions dictate.

In Multiplex control, the Master VFD will utilize the Lead/Lag Parameters and logic similar to lead/lag control in order to decide when to turn on/off a VFD. More detail on the logic behind these decisions will be given in a later section.

It is not recommended to run an auxiliary pump directly from the Master VFD. The Master rotates which unit is the Primary, which could result in a single auxiliary pump operating across-the-line at 60 Hz in a bang-bang control system. The Primary Auxiliary Pump could turn on/off resulting in the system pressure oscillating from **(psi SETPOINT – STAGE PSI LAG)** to **(psi SETPOINT + DESTAGE PSI LAG)**.

The Master VFD stages in VFDs in a different order depending on which VFD is the Primary. When the Master VFD is not the Primary, it will ALWAYS be the second drive to be staged in.

Table 15 and **Table 16** below will illustrate the order of the VFDs to be staged or de-staged for different values of **NUMBER LAG PUMPS**.

The Primary drive position will rotate based on the parameter **DUPLEX CYCLE TIME**.

Table 15 - Master + 1 Slave VFD

Master + 1 Slave VFD		
Rotation	Primary Drive	VFD Order
1 st Rotation	Master	M <=> 1
2 nd Rotation	Slave VFD 1	1 <=> M

Table 16 - Master + 2 Slave VFD

Master + 2 Slave VFD		
Rotation	Primary Drive	VFD Order
1 st Rotation	Master	M <=> 1 <=>> 2
2 nd Rotation	Slave VFD 1	1 <=> M <=>> 2
3 rd Rotation	Slave VFD 2	2 <=> M <=> 1

Two conditions must be met to stage in a VFD:

1. The system has decreased to a pressure equal to **psi SETPOINT** minus **STAGE PSI LAG**.
 - a. Primary Slave VFDs and Primary Master Drives will ignore the **STAGE PUMP DELAY** parameter, and immediately stage in if the system pressure drops below the threshold.
2. The time set by **STAGE PUMP DELAY** has expired. This delay allows a momentary drop in system pressure without calling for a drive to stage in.

The procedure to stage a drive is described below:

1. The selected drive will be staged in. The selected drive is based on the order given in
2. **Table 15** and **Table 16** above. This will either close the Slave VFD's corresponding relay or move the Master VFD out from sleep mode.
3. The speed of the main pump will decrease to a value equal to **MAX FREQUENCY** minus the corresponding **STAGE FREQ REDUCTION**.
4. The Master VFD will operate at a reduced speed for a period of time set by **STAGE TIME**.
5. When **STAGE TIME** has expired the system will resume normal constant pressure control.

Note: The Master VFD does NOT have corresponding **STAGE FREQ REDUCTION** or **STAGE TIME** parameters.

Drives are de-staged when the drive has slowed the main pump to maintain control pressure and the Slave VFD(s) causes a rise in pressure.

Three conditions must be met to de-stage a VFD:

1. The system psi has increased to the value set by **psi SETPOINT** plus **DESTAGE PSI LAG**.
2. The time set by **DESTAGE PUMP DELAY** has expired. This delay prevents de-staging VFDs due to momentary pressure overshoot.
3. The Master drive frequency is between **MIN FREQUENCY** and the value of **MIN FREQUENCY** plus **DESTAGE MIN FREQ**.

The procedure to de-stage a drive is described below:

1. The selected drive will be de-staged. The selected drive is based on the order given in
2. **Table 15** and **Table 16** above. This will either open the Slave VFD's corresponding relay or set the Master VFD to sleep mode.
3. The frequency of the main pump will increase by **DESTAGE FREQ BOOST**.
4. The Master VFD will operate at an increased speed for a period of time set by **DESTAGE TIME**.
5. When **DESTAGE TIME** has expired the system will resume normal constant pressure control.

Note: Setting PROGRAM RELAY 1 to setting 6, Jockey Pump, will cause Relay 1 to not participate in lead/lag or multiplex control. The order pumps are staged or destaged will remain the same, except the Master will skip Relay 1. Relay 1 will also never become the Default when it is set to the Jockey Pump setting.

6.7 Tank Sizing

For constant pressure systems, a pressure tank should be used. The tank should be at least 20% of the pump's rated flowrate in Gallons Per Minute (GPM). For instance, a pump rated 10 GPM requires at least a 2-gallon tank.

For proper pressure control, the pre-charge pressure of the tank should be set to 70% of the desired pressure setpoint. Use the formula below to ensure proper tank pre-charge pressure.

$$\textit{Tank Precharge Pressure} = \textit{psi Setpoint} \times 0.7$$

6.8 Troubleshooting Constant Pressure Systems

A variety of conditions in a plumbing system can lead to less than optimum performance of constant pressure control while using the factory default settings. The default settings are designed to operate a range of plumbing systems, but there can be many variables in a plumbing system that requires adjustment of the constant pressure parameters.

For the drive to enter sleep mode while operating in constant pressure mode, three conditions must be met:

1. The pressure in the system must be at the pressure control point set by the parameter ***psi SETPOINT***.
2. The frequency declines to the shut off frequency (defined as ***MIN FREQUENCY*** plus ***SHUTOFF FREQUENCY***).
3. The time expired since the pump started after the last OFF cycle must be greater than parameter ***T1ON*** or ***T2ON***

When these conditions have been met, the drive will go to sleep. The duration of which the drive is asleep depends on the rate at which the system bleeds down and the width of the dead band. When setting and testing a constant pressure system, try to operate as close as possible to the normal operating conditions. Low flow in a high-capacity system (and vice versa) usually requires some adjusting of the parameters.

7 TROUBLESHOOTING

This section provides information on fault codes and troubleshooting tips for potential system problems.

 **WARNING!** In some instances, the unit will shut down, then automatically restart when conditions allow. Always disconnect input power from the unit and wait for internal electrical charges to dissipate before performing service on the unit or its connected loads.

 **WARNING:** Risk of electric shock. De-energize the unit by disconnecting all incoming sources of power, then wait 5 minutes for internal charges to dissipate before servicing the equipment.

 **HIGH VOLTAGE:** This equipment is connected to line voltages that can create a potentially hazardous situation. Electric shock could result in serious injury or death. This device should be installed and serviced only by trained, licensed, and qualified personnel. Follow instructions carefully and observe all warnings.

Always check the LCD display for fault codes if the drive or its load is not operating. Disconnecting the input power could potentially clear any fault code indication, possibly losing valuable information for troubleshooting.

7.1 Fault Codes

Fault codes are indicated on the graphic display. See **Table 17** for a list of fault codes.

The drive can be programmed to automatically restart after certain faults and a time delay can be programmed before the restart is allowed. To interrupt a time delay countdown and allow auto restart, press both arrow keys on the keypad and hold for one second. The load will start immediately. The Restart Log is a resettable fault log that can be used to monitor faults that allow auto restart. Use the Clear Memory function to reset the Restart Log and set all fault counters to zero. See **Section 3.4, Keypad Main Menu Items**, for more information on Restart Log and Clear Memory function.

 **WARNING:** Certain faults do not allow an auto restart. These faults generally indicate the possibility of damage to the drive and/or the load or indicate the possibility of a dangerous condition. When this type of fault occurs, the display will read **NO AUTO RESTART**. Refer to **Table 17, Fault Codes**, to determine if the fault allows an auto restart. The number 1 in the note's column indicates that auto restart is not allowed. When this type of fault occurs, contact the factory for assistance before restarting or troubleshoot the system thoroughly. These faults can be cleared only by cycling input power OFF/ON.

 **WARNING:** Unit may restart automatically without warning after a fault when operating conditions permit. Make certain input power is disconnected before servicing the unit or its connected loads.

7.2 Clearing a Fault

If the unit is programmed to automatically restart after a particular fault, the display indicates that the unit will restart and will count down the seconds remaining to restart on the display. The countdown can be interrupted by pressing and holding both arrow keys. The load will immediately restart.

For faults that allow an automatic restart, the default number of restarts after a fault is zero. If the end user desires the unit to automatically restart after a fault, the number of restarts allowed and the time between fault and restart must be programmed in the **CHANGE PARAMETER VALUES > AUTO RESTART PARAMETERS** for that fault.

If the drive has exceeded the programmed number of auto restarts, or if auto restarts have not been enabled, the display will indicate the fault on the top line and the second line will read **RESTART? ENTER**. Press ENTER to clear the fault and restart the load. The fault counters in the Restart Log will all be reset to zero. See **Section 3.8, Restart Log**, for more information.

The **ENABLE RESTART** parameter allows the drive to restart automatically after a fault. This parameter also enables the drive to initialize in AUTO mode when the input power has been cycled OFF/ON and the drive is energized. The factory default setting does not allow auto restarts. Navigate to this parameter via **CHANGE PARAMETER VALUES > AUTO RESTART PARAMETERS > ENABLE RESTART**. See **Table 11** for values in setting the parameter.

Certain faults do not allow an auto restart. These faults generally indicate the possibility of damage to the drive and/or the load or indicate the possibility of a dangerous condition. When this type fault occurs, the display will read **NO AUTO RESTART**. When this type of fault occurs, contact the factory for assistance before restarting or troubleshoot the system thoroughly. These faults can be cleared only by cycling input power OFF/ON.

There are several conditions where the drive will indicate a fault, but the fault will not be recorded in the fault log. These faults occur only when the drive is energized from utility mains and is initializing. If any of three conditions including ground fault, high input voltage or low input voltage is detected, the display will indicate the fault and wait for the condition to resolve before entering normal operating mode. If these conditions occur after the drive has initialized, a fault will be logged and can be cleared in the normal manner.



 **WARNING:** The drive may start automatically without warning when operating conditions permit. Make certain input power is disconnected before servicing the unit or its connected loads.

Table 17 – Fault Codes

TEXT MESSAGE	DESCRIPTION / COMMENTS	NOTES
15V DC POWER OVERLOAD	Indicates closed circuit. Check for short circuit between lines. Check the polarity of the wires on I_1+ and I_1- . System may also say SLEEP . Check the 4-20 mA reading in Read Measured Values.	2
BROKEN PIPE FAULT	Broken Pipe fault. Indicates the possibility of a broken pipe.	1
BUS OVERVOLTAGE	Sudden and severe regenerative power under high line voltage conditions may result in bus overvoltage. Check line voltage or increase ramp up and ramp down times.	2
DRY WELL CURRENT	Motor current has fallen below the value set in UNDERCURRENT LIM Commonly used to detect dry well condition.	P, 2
GROUND FAULT	A fault between an output line and earth has been detected. Immediately disconnect input power and check output lines with a megger to verify a fault. Nuisance trip is a possibility. Sensitivity of fault detection can be adjusted by the Operating Parameter GND FAULT DETECT . See Table 10 for details.	1
HIGH INPUT VOLTAGE	Input voltage has exceeded a level for safe operation. Reduce input voltage. General purpose buck/boost transformers are compatible with Phase Technologies drives.	2
LOW INPUT VOLTAGE	Input voltage has fallen below a level for safe operation of the drive.	2
MOTOR OVERLOAD	Output current has exceeded the value set for OVERCURRENT LIMT in OPERATING PARAMETERS menu. Check status of motor load. If output current limit is increased, make sure it is within the limit of the motor nameplate. Automatic restarts are set by RESTART DELAY 1 and RESTARTS CUR OVL in the AUTO RESTART PARAMETERS menu.	P, 2
OUTPUT FAULT	Check for short circuit on output lines and load. Replace wire nuts with solid wire or soldered splices.	1
OUTPUT OVERLOAD	Indicates a large and sudden overcurrent event on the output module. Check the motor circuit for faults. Replace wire nuts with solid wire or soldered splices. Sudden changes in the load may also have occurred such as the closing of a relay that results in an across-the-line start of a motor. Never install relays in the motor circuit.	1
OVER TEMPERATURE	Internal temperature of the drive exceeded safe limits. Check fans and ventilation openings for obstruction. Reduce ambient temperature.	2
PRECHARGE FAIL	DC bus voltage did not reach normal level. Possible failure of input diode.	3
SENSOR CONNECTION FAIL	Indicates open circuit. 4-20mA analog signal is not present on Control Terminals I_1 and I_2. This could indicate failure of the 4-20mA sensor or that the cables from the sensors have been disconnected.	2

P = Fault may be related to an adjustable parameter. Always check the value of the parameter to eliminate nuisance tripping.

1 = Drive has shut down due to a potentially dangerous condition. Drive will remain OFF until input power is cycled OFF/ON. Use caution if the drive is restarted.

2 =  **WARNING:** Auto restart allowed for this fault. Motor may restart automatically without warning after a fault when operating conditions permit. Make certain input power is disconnected before servicing the unit or its connected loads.

Fault Log

The Fault Log records the number of times a particular fault has occurred. To access the Fault Log, press the MENU key until the Main Menu item, **FALUT LOG**, appears. Press ENTER key to access the list of faults.

The Fault Log will continue to log the number of faults that have occurred until it is reset through the Main Menu item **RESTART LOG or CLEAR MEMORY**. The Fault Log is not to be confused with the restart counter. The restart counter is associated with the automatic restart function and is reset whenever the input power is cycled OFF/ON.

Table 18 - Troubleshooting

PROBLEM	POTENTIAL CAUSE	SOLUTION
Motor not running	Is a fault code indicated?	Based on the fault code, resolve any factors that are likely causing the fault. Clear the fault by pressing both arrow keys on the keypad or by cycling input power OFF/ON.
	Are the remote switches AUX1 and AUX2 closed?	Check the status of the switches or jumpers connected to AUX1 and AUX2 on the Control Terminals. The LCD display indicates the status of AUX terminals in the default display mode. All AUX terminals must be closed for the motor to run in AUTO mode.
	Are the signals to the Control Terminals corrupted?	Shielded cable is required for AUX terminal switch leads longer than 20 ft. Regular wire will induce capacitance in the line and corrupt control signals. Shielded cable is recommended for all Control signal cables.
	Is the keypad in MAN or OFF mode?	The keypad will override signals on the Control Terminals when OFF or MAN is selected. Keypad must be in AUTO mode for external control signals to control the motor.
	Is the maximum frequency set at 0 Hz?	Check the maximum frequency by using the keypad to navigate MAIN MENU>CHANGE PARAMETER VALUES>OPERATING PARAMETERS>MAX FREQUENCY .
	Are the input terminals L1 and L2 energized?	Check the main breaker.
Motor is turning the wrong direction	Phase sequence on output terminals U/T1, V/T2, W/T3 is out of order	Swap any two of the three motor leads on the output terminals.

8 ROUTINE INSPECTION AND MAINTENANCE

The unit should be inspected and cleaned at least annually or more frequently if it is in an excessively warm or dusty environment.

Overall: Perform a visual inspection checking for things such as discolored wires or terminals, evidence of arcing, loose mounting screws, physical damage to the enclosure, etc.

Power terminals: Inspect for loose connections and tighten to specifications in **Table 3**.

Capacitors: Check for leakage or deformation.

Fans and heatsinks: Excessive dust buildup on the heatsink and cooling fan impellers may lead to overheating. Lightly brush and vacuum clean.

Instructions for fan replacement: Contact Customer Service for assistance in replacing the cooling fan in the event it should fail. Use only fans approved by Phase Technologies. Unapproved fans may not be able to move enough air to properly cool the unit, leading to component damage not covered under warranty.

9 MODELS AND RATINGS

9.1 Model Nomenclature

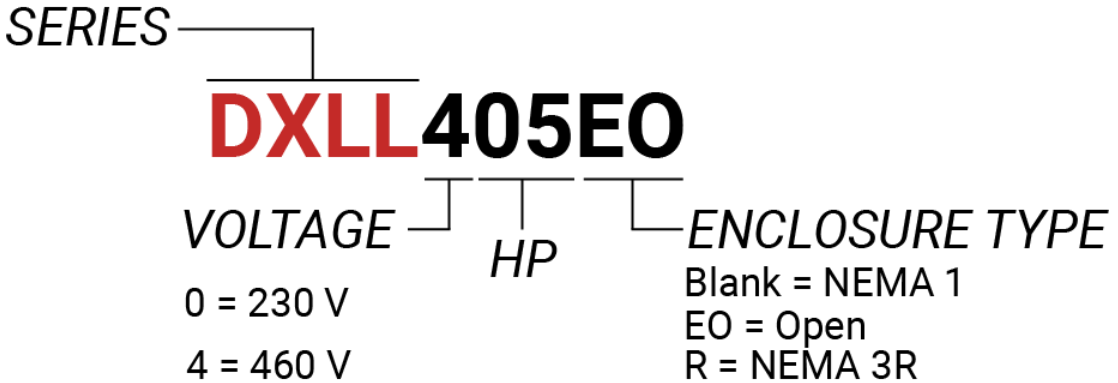

Figure 16 – DXLL Series Nomenclature

9.2 Model Ratings

Table 19 – DXLL Series Model Ratings

DXLL Series							
Model	Rated HP/kW	Rated Input Voltage	Rated Output Voltage	Rated Input/Output Current	1-Phase Output Current	Switching Frequency*	Weight
DXLL002/R	2/1.5	120 - 240 V, 3-phase	$V_{OUT} = V_{IN}$, 3-phase	9 A	4.5 A	2-5 kHz	15 lbs
DXLL003/R	3/2.2			12 A	6 A		15 lbs
DXLL005/R	5/4			18 A	9 A		16 lbs
DXLL402/R	2/1.5	120 – 480 V, 3-phase	$V_{OUT} = V_{IN}$, 3-phase	4 A	2 A		16 lbs
DXLL403/R	3/2.2			5.4 A	2.7 A		16 lbs
DXLL405/R	5/4			9 A	4.5 A		17 lbs

*Factory default for Switching Frequency is 2 kHz. Switching Frequency is an adjustable parameter set through the keypad. Weights do not include optional output filter.



LIMITED WARRANTY

This Limited Warranty applies to the following Phase Technologies' product lines.

1. DXLL Series VFDs (variable frequency drives): Two Years

VFDs are warranted against defects in material and workmanship. This warranty covers both parts and labor from the date of purchase from Phase Technologies. Phase Technologies will repair or replace (at our option), at no charge, any part(s) found to be faulty during the warranty period specified. The warranty repairs must be performed by/at a Phase Technologies Authorized Service Center or at Phase Technologies LLC, Rapid City, SD.

Obligations of Customer

1. The original Bill of Sale must be presented in order to obtain "in-warranty" service. Transportation to Phase Technologies or an Authorized Service Center is the responsibility of the purchaser. Return transportation is provided by Phase Technologies.
2. Installations must comply with all national and local electrical codes.

Exclusions of the Warranty

This warranty does not cover any of the following: accident, misuse, fire, flood, and other acts of God, nor any contingencies beyond the control of Phase Technologies, LLC, including water damage, incorrect line voltage, improper installation, missing or altered serial numbers, and service performed by an unauthorized facility. Phase Technologies' liability for any damages caused in association with the use of Phase Technologies' equipment shall be limited to the repair or replacement only of the Phase Technologies' equipment. No person, agent, distributor, dealer, or company is authorized to modify, alter, or change the design of this merchandise without express written approval of Phase Technologies, LLC.

Installations must comply with all national and local electrical code requirements.