

Important Product Notice

Please be aware this product series is no longer in active production.

Sales Department

Contact a Phase Technologies technical sales staff member for its replacement.

Toll Free: 866-250-7934 Select #1 for the Sales Department
Phone: 605-343-7934

Service or Repair

For service or repair related questions or requests – please contact our service department.

Phase Technologies Service Department

Toll Free: 866-250-7934 Select #2 for the Service Department
Phone: 605-343-7934





Phase Technologies, LLC
231 East Main Street North
Rapid City, SD 57701
www.phasetechnologies.com





SAFETY MESSAGES AND WARNINGS









To ensure safe and reliable operation of the APG Series variable frequency drive, it is important to carefully read this manual, and to read and observe all warning labels attached to the drive before installing the equipment. Please follow all instructions exactly, and keep this manual with the equipment at all times for quick and easy reference.











Definitions of Warning Signs and Symbols

-  **CAUTION:** Indicates a potentially hazardous situation that could result in injury or damage to the product.
-  **WARNING:** Indicates a potentially hazardous situation that could result in serious injury or death.
-  **HIGH VOLTAGE:** Indicates high voltage. The voltage associated with the procedures or operations referenced could result in serious injury or death. Use caution and follow instructions carefully.

READ THESE WARNINGS BEFORE INSTALLING OR OPERATING THE EQUIPMENT!

-  **WARNING:** Risk of electric shock. De-energize the unit by disconnecting all incoming sources of power, then wait 5 minutes for internal charges to dissipate before servicing the equipment.
-  **HIGH VOLTAGE:** This equipment is connected to line voltages that can create a potentially hazardous situation. Electric shock could result in serious injury or death. This device should be installed only by trained, licensed and qualified personnel. Follow instructions carefully and observe all warnings.
-  **WARNING:** This equipment should be installed and serviced by qualified personnel familiar with the type of equipment and experienced in working with dangerous voltages.
-  **WARNING:** Installation of this equipment must comply with the National Electrical Code (NEC) and all applicable local codes. Failure to observe and comply with these codes could result in risk of electric shock, fire or damage to the equipment.

-  **CAUTION:** The AUX1, AUX2, AUX3 and AUX4 terminals are galvanically isolated, with approximately 5V potential between them. DO NOT apply a voltage to the terminals. Use dry contacts only.
-  **CAUTION:** Circuit breakers or fuses, proper ground circuits, disconnects and other safety equipment and their proper installation are not provided by Phase Technologies, LLC, and are the responsibility of the end user.
-  **CAUTION:** Long leads between the unit and the motor with an unfiltered PWM voltage can lead to dangerous voltage rise from reflected harmonics. Very long leads, such as in deep well submersible pump applications, may require the use of a sine wave filter to remove most of the harmonics from the waveform. Consult the factory or a knowledgeable source on drive filters if your application has more than 50 feet between the drive and the motor.
-  **CAUTION:** Failure to maintain adequate clearance may lead to overheating of the unit and cause damage or fire.
-  **WARNING:** Suitable for use in a circuit capable of delivering not more than 10 kA RMS symmetrical amperes, 240 V maximum for all models with 240V class input (refer to model nomenclature).
-  **WARNING:** Suitable for use in a circuit capable of delivering not more than 10 kA RMS symmetrical amperes, 480 V maximum for all models with 480V class input (refer to model nomenclature).
-  **WARNING:** Wire used within the motor circuit and all field wiring terminals must be rated at least 75 C.
-  **WARNING:** Use wire size suitable for Class 1 circuits.
-  **WARNING:** Input power connections should be made by a qualified electrician into a nominal 240V circuit for models with 240V input, or a nominal 480V circuit for models with 480V input, with adequate current carrying capacity. Branch circuit protection to the drive should be provided by appropriate size fuses or a 2 pole, linked circuit breaker. Circuit breaker and fuse ratings for each model are listed in Table 3-3.

-  **WARNING:** These devices are equipped with integral solid state short circuit protection. Integral solid state short circuit protection does not provide branch circuit protection. Branch circuit protection must be provided in accordance with the National Electrical Code and any additional local codes.
-  **CAUTION:** Use 600 V vinyl-sheathed wire or equivalent. The voltage drop of the leads needs to be considered in determining wire size. Voltage drop is dependent on wire length and gauge. Use Copper Or Aluminum Conductors.
-  **CAUTION:** Wires fastened to the terminal blocks shall be secured by tightening the terminal screws to a torque value listed in Table 3-2.
-  **CAUTION:** The input wire gauge must be sized to accommodate the single-phase input current, which will be significantly larger than the three-phase output current to the load.
-  **CAUTION:** The maximum wire gauge for the input terminals is listed in Table 3-2.
-  **CAUTION:** Never allow bare wire to contact the metal surfaces.
-  **CAUTION:** Never connect AC main power to the output terminals U/T1, V/T2, and W/T3.
-  **WARNING:** Under certain conditions, the motor may automatically restart after a trip has stopped it. Make sure power to the drive has been disconnected before approaching or servicing the equipment. Otherwise, serious injury may occur.
-  **CAUTION:** Before applying power to the main input terminals of the unit, make certain that at least one of the switches or jumpers connected to AUX1, AUX2, AUX3 and AUX4 is open. Otherwise, the motor load may start as soon as the drive is energized.
-  **CAUTION:** The AC motor load must be connected directly to the output terminals of the converter. Do not install relays or disconnect switches between the converter and the motor load.
-  **CAUTION:** Before the motor is connected to the output terminals, check all output lines for line-to-ground faults using a megger. There is a direct path through the drive circuitry for ground fault currents that can be triggered when power is applied to the input terminals, even though the output switches are not activated. These currents can cause serious damage to drive circuitry and are not covered under warranty.

 **CAUTION:** Before touching any printed circuit board, place a hand on a bare metal surface of the unit to discharge any static electricity. Electrostatic discharge (ESD) can damage printed circuits and their components.

 **CAUTION:** When the AUTO RESTARTS parameter is enabled the drive will energize in AUTO mode. The motor load will automatically run if AUX1, AUX2, AUX3 and AUX4 remote switches are closed. To stop the motor, push MAN (manual) or OFF, or open AUX1, AUX2, AUX3 or AUX4. The RUN and STOP keys only work when in MAN mode. Refer to the section on Keypad and Display for instructions on operating the keypad.

 **CAUTION:** Operating the system in MAN mode on the keypad overrides signals from the pressures switches. Operating the system in this mode may lead to dangerous pressures in closed plumbing systems

 **CAUTION:** Even when the drive complies with IEEE 519 there may be enough high frequency noise on the line to interfere with or even to damage utility smart meters. Consult with your utility or the manufacturer about meter filtering options before operating the drive.

 **CAUTION:** Engaging a brake resistor is the equivalent of a dead short on the DC bus. Damage to the IGBTs is likely without the protection of the Brake Sense circuit.

 **WARNING:** The Brake Sense circuit will be at a potential equal to the DC bus voltage. Little, if any, current will flow in this circuit.

 **WARNING:** Do not connect a brake resistor to the Brake Sense terminal when the terminal is also jumpered to VDC Pos. Serious damage to the drive and brake resistor will occur.

TABLE OF CONTENTS

Safety Messages and Warnings	i
Contact Information	vii

Section 1: Introduction

1.1 APG Series Design.....	1-1
Line Side Converter.....	1-1
Low Line Side Harmonics.....	1-2
Voltage Boosting.....	1-2
Line Side Inverter.....	1-2
1.2 Model Nomenclature.....	1-3
1.3 Base Models and Ratings.....	1-3
1.4 Weights.....	1-5
1.5 Dimensional Drawings.....	1-6

Section 2: System Configuration

2.1 System Configuration	2-1
Line Side Harmonics.....	2-1
Power Regeneration.....	2-2
Mitigating Electromagnetic Interference (EMI).....	2-2
Output Filters.....	2-2
2.2 System Configuration Settings.....	2-3
2.3 Brake Resistors.....	2-3

Section 3: Installation

3.1 Physical Installation.....	3-1
Integration by UL 508 Panel shops.....	3-2
3.2 General Wiring Considerations.....	3-3
Table 3-1 Power Terminal Descriptions.....	3-4
Table 3-2 Field Wiring Power Terminal Specifications.....	3-4
Table 3-3 Input Circuit Breaker and Fuse Ratings.....	3-5
3.3 Control Terminals.....	3-6
Table 3-4 Control Terminal Ratings and Descriptions.....	3-7
0-5 VDC Analog Input.....	3-10
0-5 VDC Transducer (Potentiometer).....	3-11
4-20 mA Analog Transducer.....	3-12
3.4 Installing Power Cables.....	3-13

Section 4: Keypad and Display

4.1 Using the Keypad and Display.....	4-1
Auto-Dimming Display.....	4-2
Default Display Mode.....	4-2
Keypad Display Messages.....	4-2
4.2 Keypad Main Menu Items.....	4-3
Read Measured Values.....	4-4
Read and Edit Timers.....	4-7
Fault Log.....	4-9
Auto Tuning Mode.....	4-10
Change Parameter Values.....	4-11

Section 5: Adjustable Parameters

5.1 Changing Parameter Values.....	5-1
Restore Default Parameter Settings.....	5-3
Reset the Fault Counter.....	5-3
Table 5-1 Operating Parameters.....	5-4
Table 5-2 Auto Restart Parameters.....	5-6
Table 5-3 Constant Pressure Parameters.....	5-7
Table 5-4 Torque Control Parameters.....	5-9
Table 5-5 Interface Parameters.....	5-11
Table 5-6 Wind Turbine Parameters.....	5-14

Section 6: Operation

6.1 Commissioning the Unit.....	6-1
Ground Fault Detection.....	6-1
Initial Operation.....	6-1
6.2 Motor Overload Protection.....	6-3
6.3 System Configuration.....	6-3
6.4 Start-Up and Shut-Down Ramp Times.....	6-4
Minimum Frequency.....	6-4
6.5 Controlling Motor Speed with Analog Input.....	6-6
Analog Input and Minimum Frequency.....	
6.6 Sensorless Vector Torque Control.....	6-8
Auto Tuning.....	6-8

Section 7: Constant Pressure Systems

7.1 Control Principles of Constant Pressure Systems.....	7-1
Preventing Short Cycling During Low Flow Conditions.....	7-1
Controller Gain and Ramp Time.....	7-2
Emergency Over-Pressure Limit Switch.....	7-3
7.2 Troubleshooting Constant Pressure Systems.....	7-3
SHUTOFF P_{MIN} Too Low.....	7-4
Adjusting Gain in an Analog CP System.....	7-4
Pressure Control at Minimum Speed.....	7-6
Boost in a Digital CP System.....	7-6
7.3 Digital Constant Pressure Systems.....	7-7
7.4 Analog Constant Pressure Systems.....	7-10
7.5 Pre-Charge Mode.....	7-14
7.6 Duplex Systems.....	7-15

Section 8: Wind Turbine Control

8.1 Activation of Wind Turbine Parameters.....	8-1
8.2 Upper and Lower Speed Limits.....	8-2
8.3 Tracking Peak Power with Variable Speed Operation.....	8-3
8.4 Speed Bands.....	8-5

Section 9: Troubleshooting

9.1 Status Indicators and Fault Codes.....	9-1
Clearing a Fault.....	9-2
Table 9-1 Fault Codes.....	9-2
Fault Log.....	9-5
Table 9-2 Troubleshooting.....	9-6
9.2 Routine Inspection and Maintenance.....	9-7
Fuses.....	9-7

Section 10: Network Communication

10.1 Connecting a MODBUS Network to the Drive.....	10-1
10.2 Windows Compatible Software.....	10-3

CONTACT INFORMATION

Phase Technologies, LLC
231 East Main Street North
Rapid City, SD 57701
Phone: 605-343-7934
Fax: 605-343-7943
www.phasetechnologies.com

©Copyright. All rights reserved. All contents are property of Phase Technologies, LLC.

No portion of this publication or its contents may be duplicated by any means, electronic or otherwise, without the express written consent of Phase Technologies, LLC.

Version 1.11

APG Series variable frequency drives (VFD) are inverter-based devices that convert single-phase input to three-phase variable frequency output to provide speed control for three-phase AC motors. The drives have regenerative capability, allowing regenerative power from the load to pass through the converter back to the line side power source. APG Series drives are equipped with either an LCL or LC filter on the line-side module, resulting in very low harmonic distortion of utility power.

1.1 APG Series Design

The simplified block diagram below demonstrates how the APG Series drive converts the incoming single-phase AC power to DC, then utilizes an inverter module to generate three-phase variable voltage and frequency output to control the speed of the motor.

Figure 1 APG Series Block Diagram

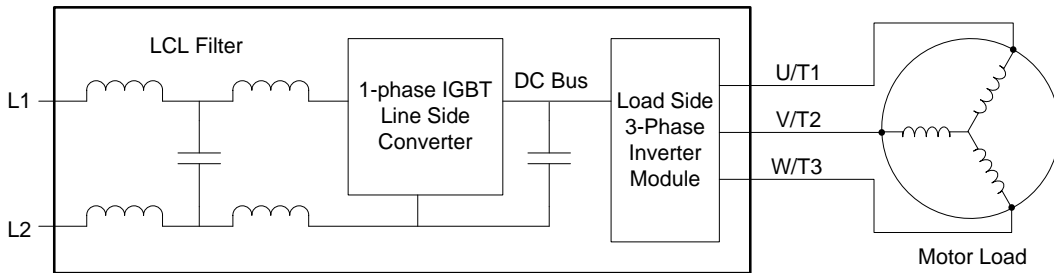

Line Side Converter

The single-phase line side converter consists of an IGBT module with an LCL filter or an LC filter. This module employs electronic power factor correction, drawing the input current as a sine-wave, eliminating the current distortion and line harmonics associated with a diode rectifier bridge. The line side converter can also boost the DC bus voltage, which allows the inverter module to produce 480V output voltage from a 240V line voltage on some models. APG Series drives are fully regenerative, allowing any power generated on the load side to pass through to the line side.

Low Line Side Harmonics

All models of the APG Series employ electronic power factor correction on the input module. Electronic power factor correction allows the drive to draw the input current as a sine wave, greatly reducing the current distortion and line harmonics associated with a diode bridge rectifier. Because of its favorable harmonic profile, input line reactors and harmonic filters are NOT REQUIRED on the line side of an APG Series drive. Models are available with either an LC filter or an LCL filter. The LCL filter produces cleaner wave forms with lower harmonic distortion. Installations in many cases will comply with IEEE 519, the international standard for allowable harmonic distortion on utility mains.

Voltage Boosting

Unlike a diode bridge rectifier, the input module is capable of significantly boosting the voltage on the DC bus. Utilizing this feature, some models of the APG series convert 240V single-phase line voltage to 480V three-phase output. The APG Series includes models rated either 240V or 480V on the line side. All APG Series drives are rated 480V three-phase on the load side.

Load Side Inverter

The APG Series output on the load side is three-phase, pulse width modulated (PWM), variable voltage and frequency. All models are rated 480V on the load side. The APG Series employs either v/f control or sensorless vector control for outstanding low-speed performance and speed control.

 **CAUTION:** The AC motor load must be connected directly to the output terminals of the drive. Do not install relays or disconnect switches between the drive and the motor load.

Fuses or motor overload devices as required by NEC and local safety codes may be installed between the drive and the motor, however the APG Series is equipped with adjustable solid state motor overload protection.

1.2 Model Nomenclature

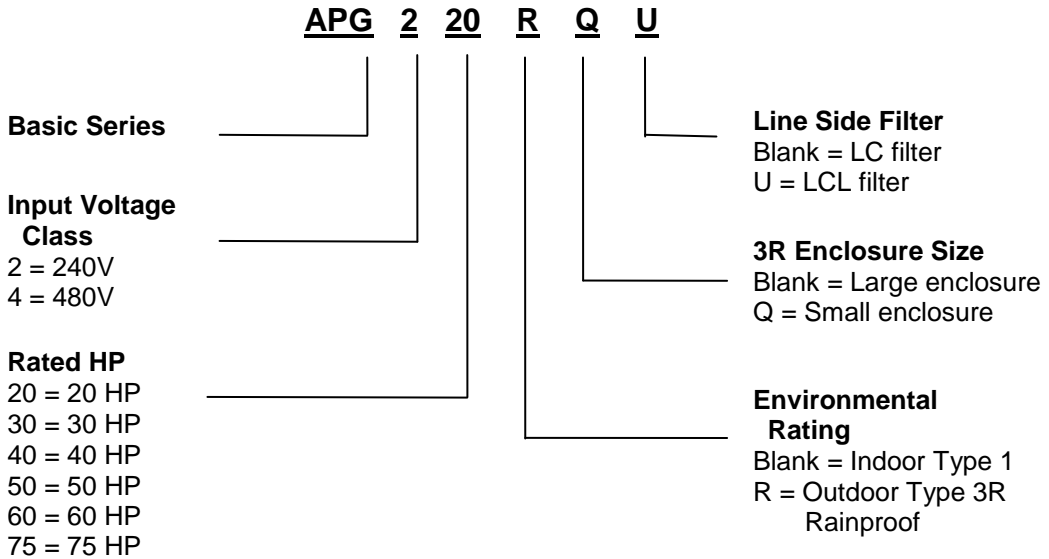

1.3 Base Models and Ratings

240V Input Models		
Model	APG220	APG230
Rated Input Voltage	1-phase, 240VAC, 50/60 Hz	
Rated Input Current (A)	97	144
Rated Output Voltage	3-phase, 380-480VAC, 50/60 Hz	
Rated Output Current (A)	30	45
Rated output KVA (480V)	25	37
Rated output KW (NEMA 90%)	16.6	24.9
Carrier Frequency*	5 kHz	

480V Input Models			
Model	APG420	APG430	APG440
Rated Input Voltage	1-phase, 480VAC, 50/60 Hz		
Rated Input Current (A)	48	72	98
Rated Output Voltage	3-phase, 440-480VAC, 50/60 Hz		
Rated Output Current (A)	30	45	62
Rated output KVA (480V)	25	37	51
Rated output KW (NEMA 90%)	16.6	24.9	33.2
Carrier Frequency*	5 kHz		

480V Input Models continued...			
Model	APG450	APG460	APG475
Rated Input Voltage	1-phase, 480VAC, 50/60 Hz		
Rated Input Current (A)	121	143	170
Rated Output Voltage	3-phase, 440-480VAC, 50/60 Hz		
Rated Output Current (A)	77	91	107
Rated output KVA (480V)	64	75	89
Rated output KW (NEMA 90%)	41.4	49.7	62.2
Carrier Frequency*	5 kHz		

*Factory default for Carrier Frequency is 5 kHz. Carrier Frequency is an adjustable parameter set through the keypad.

1.4 Weights

Model / Options	Weight (lbs)		Model / Options	Weight (lbs)
APG220	155		APG440	173
With LCL filter	172		With LCL filter	190
With Small 3R Enclosure	189		With Small 3R Enclosure	192
With Large 3R Enclosure	257		With Large 3R Enclosure	260
APG230	204		APG450	180
With LCL filter	219		With LCL filter	195
With Small 3R Enclosure	221		With Small 3R Enclosure	199
With Large 3R Enclosure	291		With Large 3R Enclosure	267
APG420	150		APG460	220
With LCL filter	175		With LCL filter	241
With Small 3R Enclosure	181		With Small 3R Enclosure	261
With Large 3R Enclosure	249		With Large 3R Enclosure	307
APG430	165		APG475	233
With LCL filter	180		With LCL filter	255
With Small 3R Enclosure	184		With Small 3R Enclosure	254
With Large 3R Enclosure	252		With Large 3R Enclosure	320

1.5 Dimensional Drawings

APG Series Frame F1 (Type 1 Indoor)

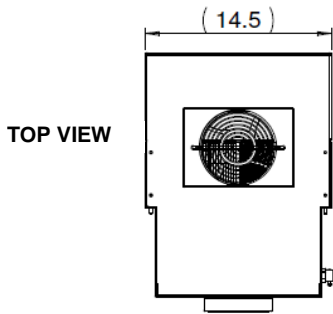

SIDE VIEW

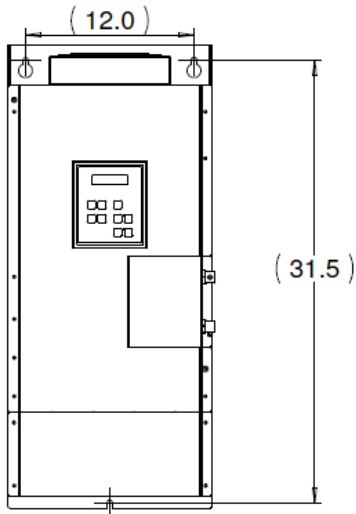
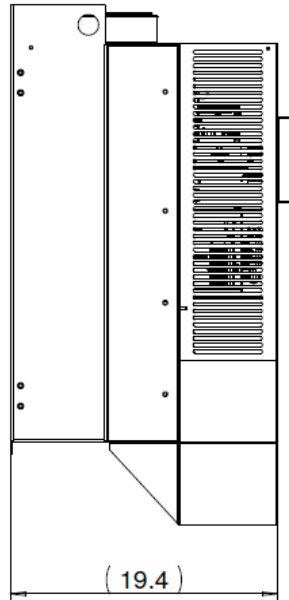

FRONT VIEW

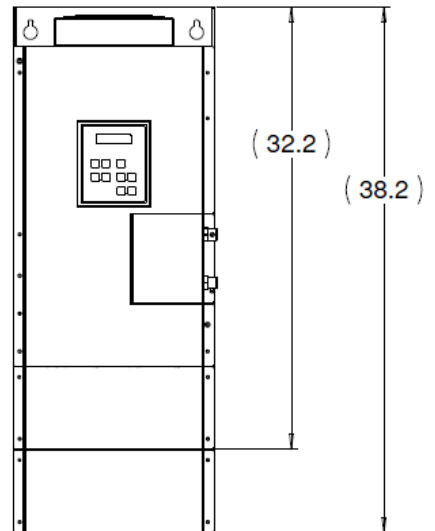

WIRE CAVITY NOT SHOWN TO DENOTE MOUNTING DIMENSIONS

APG Series Frame F2 (Type 1 Indoor)

TOP VIEW

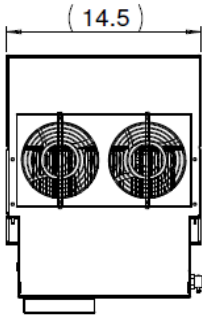

SIDE VIEW

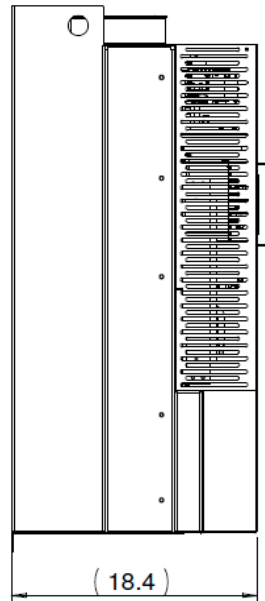

(40.0)

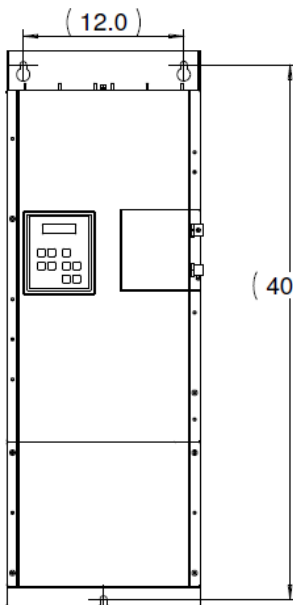

FRONT VIEW

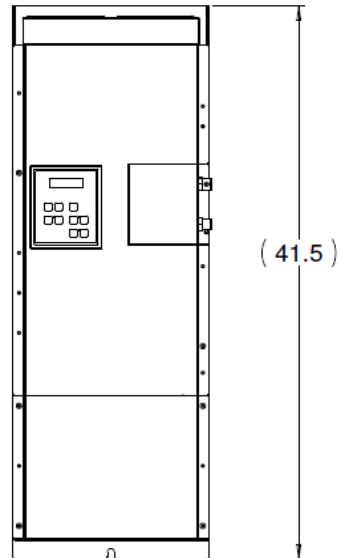

COOLING FANS NOT SHOWN TO DENOTE MOUNTING DIMENSIONS

APG Series Frame F3 (Type 3R Outdoor Rainproof)

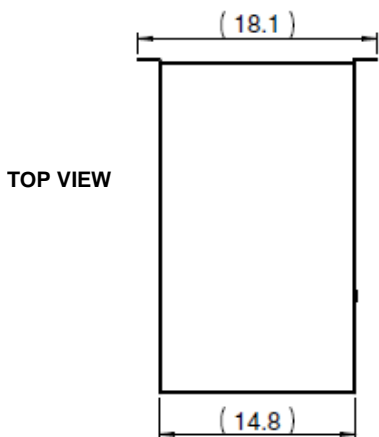

SIDE VIEW

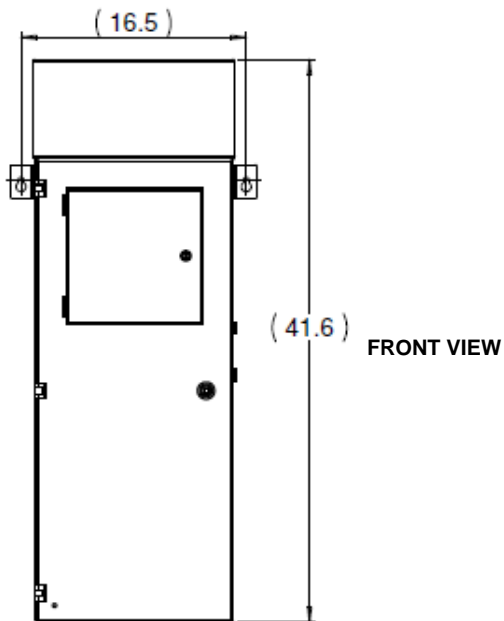
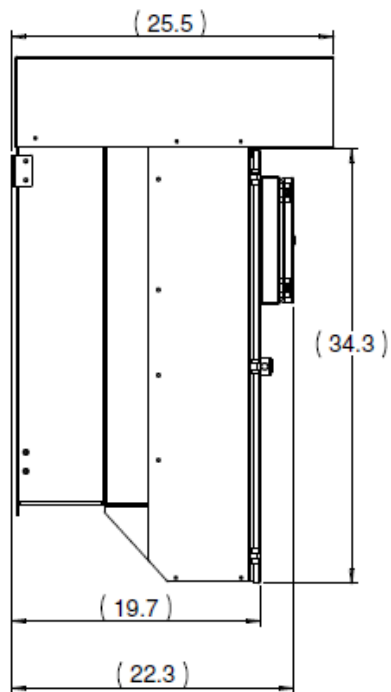

REAR VIEW

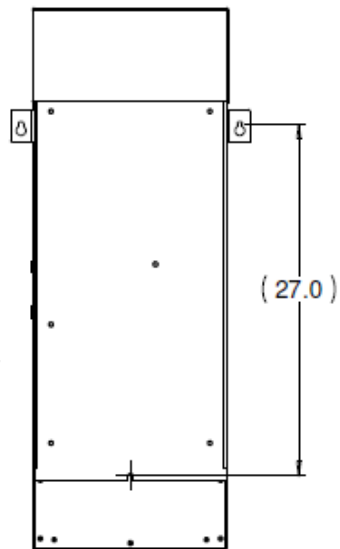

APG Series Frame F4 (Type 3R Outdoor Rainproof)

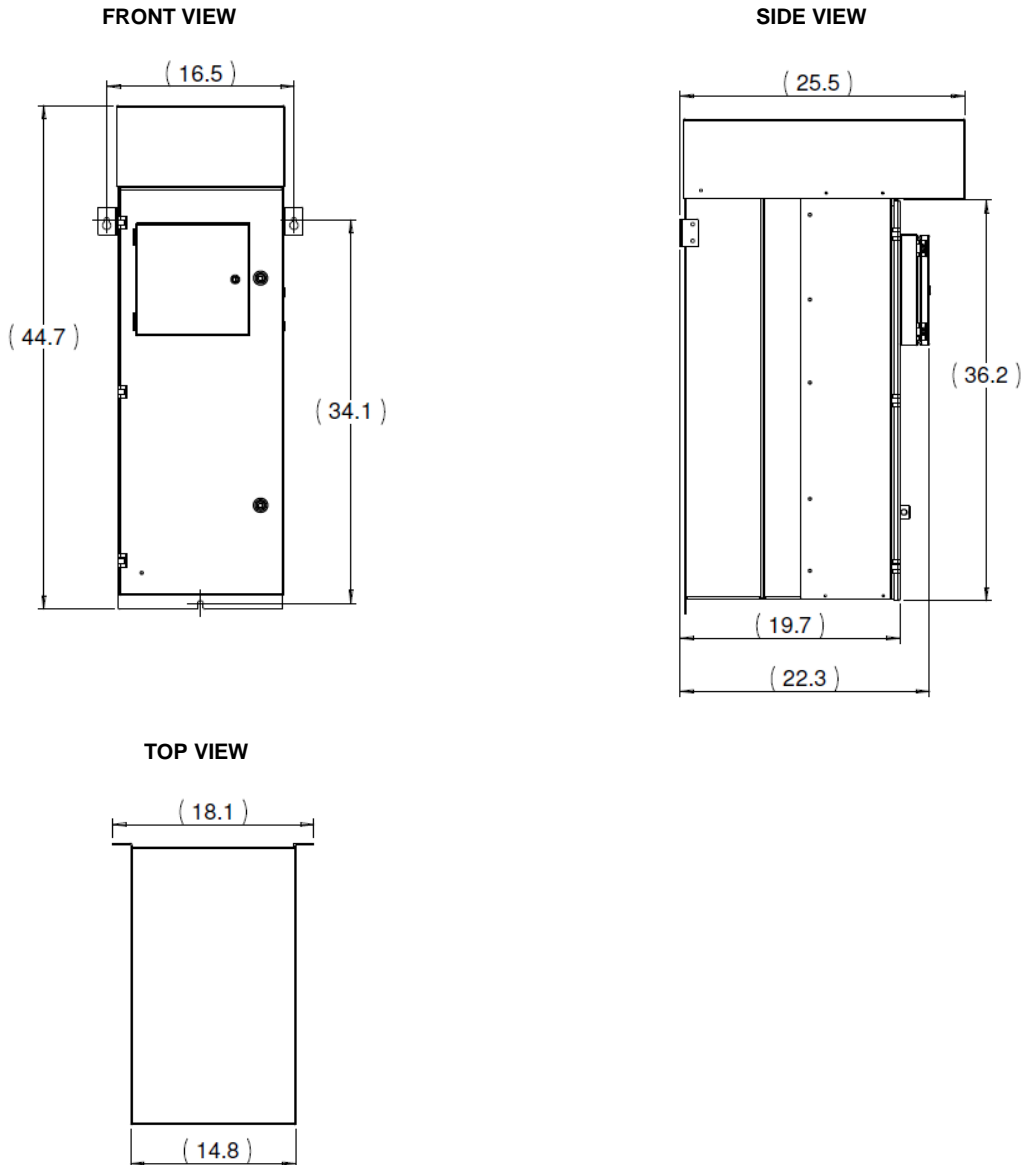

APG Series Frame F5 (Type 3R Outdoor Rainproof)

FRONT VIEW

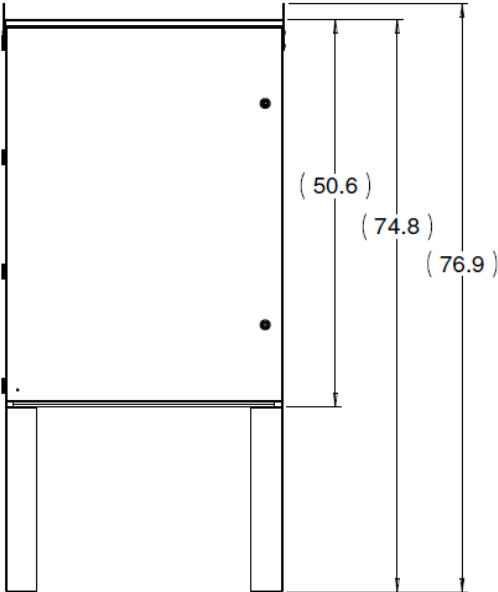

SIDE VIEW

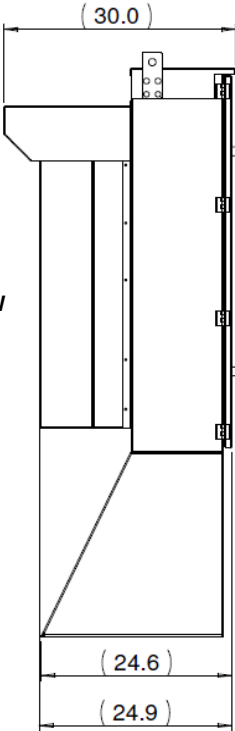

BOTTOM VIEW (for mounting hole dimensions)

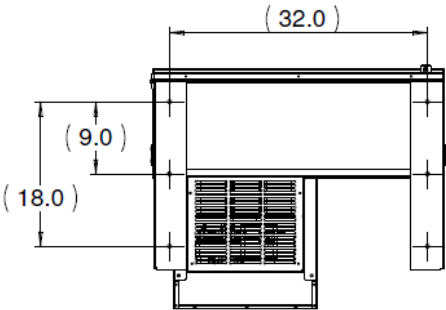

TOP VIEW

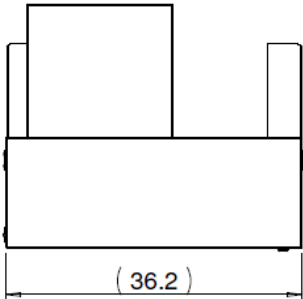

2.1 System Configuration

When used in a typical motor application, the APG Series may require the installation of several additional components. Figure 2-1 below illustrates a motor load application with components that may be required. Please remember to follow all applicable NEC and local codes to ensure safety and compliance.

⚠ CAUTION: Circuit breakers or fuses, proper ground circuits, disconnects and other safety equipment and their proper installation are not provided by Phase Technologies, LLC, and are the responsibility of the end user.

Figure 2-1 System Configuration

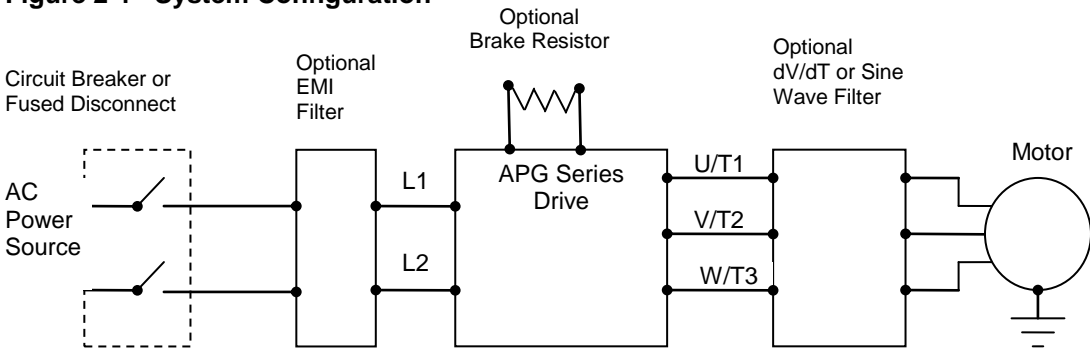

Line Side Harmonics

Because the drives have an actively controlled, power factor corrected input module, input line reactors and harmonic filters are typically not required. The input current is drawn in a sine wave, resulting in very low input current harmonics. Most other VFDs utilize a diode bridge rectifier which induces high levels of distortion in the input current.

APG Series drives are equipped on the line side with a standard LC filter or an optional LCL filter for ultra-low harmonics operation. A drive with the ultra-low harmonics option in many cases will comply with IEE519, the international standard for allowable limits on distortion of AC power mains.

Under certain conditions such as large power supply capacity or abrupt power supply changes, general purpose VFDs may also require an AC reactor on the input side to prevent large peak current flows that can destroy their input diode rectifier. An APG Series drive with

its actively controlled input module does not create these high peak currents and is therefore not susceptible to damage under these conditions. An input line reactor is not recommended.

Power Regeneration

The APG Series are fully regenerative drives. Any power generated on the 3-phase load side will be passed through to the 1-phase line side. It is not necessary to de-rate the drive or the load under this condition. The drive will regenerate power to the line side continuously at full capacity while maintaining balanced voltage and current on the load side generator.

Mitigating Electromagnetic Interference (EMI)

Devices that utilize power switching electronics, such as APG Series drives, produce high frequency emissions commonly known as electromagnetic interference (EMI). These emissions can be conducted on power cables or emitted (radiated) through the air. Conducted and emitted noise can sometimes interfere with radio signals or sensitive electronic equipment near the installation. The use of shielded cables and rigid metal conduit on the input lines on both input and output lines between the converter and the motor is recommended to help reduce EMI. An EMI Filter on the input lines helps reduce the radiated and emitted noise that can feed back from the converter to the source power. Contact the factory for assistance in choosing an EMI filter.

 **CAUTION:** Even when the drive complies with IEEE 519 there may be enough high frequency noise on the line to interfere with or even to damage utility smart meters. Consult with your utility or the manufacturer about meter filtering options before operating the drive.

Output Filters

Some installations may require a load reactor, dV/dT filter or sine wave filter between the drive and the motor. **Output filters are necessary when motor leads exceed 50 ft.** Without filters, long leads allow reflected harmonics to create dangerous voltage spikes that can exceed the insulation rating of the motor cables and windings. Over time, these voltage spikes will degrade the insulation and result in motor faults.

A filter reduces harmonics in the PWM output voltage, smoothing the waveforms to reduce vibration in the motor. Filters also reduce common mode currents in the motor windings that can discharge through motor bearings, causing pitting and premature motor failure.

 **CAUTION:** Long leads between the unit and the motor with an unfiltered PWM voltage can lead to dangerous voltage rise from reflected harmonics. Very long leads, such as in deep well submersible pump applications, may require the use of a sine wave filter to remove most of the harmonics from the waveform. Consult the factory or a knowledgeable source on drive filters if your application has more than 50 feet between the converter and the motor.

2.2 System Configuration Settings

An APG Series drive is capable of operating several types of systems, including:

- Simple ON/OFF motor control from the keypad or remote switches
- Variable speed based on analog input signals
- Digital constant pressure water systems
- Analog constant pressure water systems
- Regenerative wind turbines

Firmware in the drive interprets input signals and other data differently, depending upon the type of system being operated. It is therefore important to select the appropriate system configuration setting either through the Programmable Parameters on the keypad.

Detailed information on setting System Configuration can be found in Section 6.3, *Setting System Configuration*.

2.3 Brake Resistors

Even though APG Series drives are fully regenerative there are conditions that require a brake resistor connected to the DC bus to burn off regenerative power to prevent overvoltage of the DC bus. Permanent magnet (PM) motors and PM wind turbine generators are applications that require a brake resistor. A spinning induction motor will not produce regenerative power when the drive turns off because there is no voltage to excite the field in the motor. However, a PM motor or generator will produce power any time it is spinning, regardless of the state of the drive. Therefore if the drive should unexpectedly turn off or if it is disconnected from the utility grid, there must be an alternate path for the regenerative power. If not, dangerous increase in DC bus voltage is likely.

An APG Series drive must be equipped with optional DC Bus Terminals and Brake Sense Terminals in order to connect a brake resistor. A sense wire must be connected from the brake resistor to the Brake Sense Terminal on the drive. This circuit senses a voltage on the resistor and allows the drive to shut down its IGBTs to protect them from damage.

 **CAUTION:** Engaging a brake resistor is the equivalent of a dead short on the DC bus. Damage to the IGBTs is likely without the protection of the Brake Sense circuit.

The *Brake Sense* terminal should be connected with a sense wire to a point on the brake resistor between the IGBT chopper of the brake and the resistor.

⚠ WARNING: The Brake Sense circuit will be at a potential equal to the DC bus voltage. Little, if any, current will flow in this circuit.

Adjacent to the Brake Sense terminal is a terminal labeled *VDC Pos*. This terminal is used only when a brake resistor is not present. When a brake resistor is not present, the Brake Sense terminal must be connected to the VDC Pos terminal by a jumper wire in order for the drive to operate.

⚠ WARNING: Do not connect a brake resistor to the Brake Sense terminal when the terminal is also jumpered to VDC Pos. Serious damage to the drive and brake resistor will occur.

It is always advised to contact the manufacturer for assistance before using a brake resistor with an APG Series drive.

Figure 3-1 Brake Sense Terminal

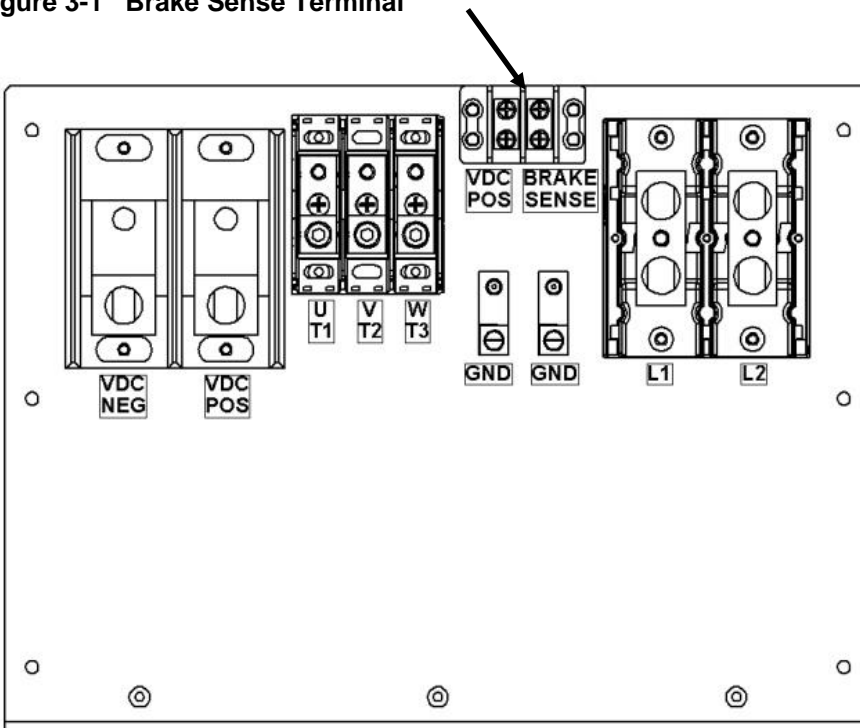

3.1 Physical Installation

The drive must be mounted in an upright position with adequate clearance for cooling and maintenance access. Models are designed for wall mounting or pad mounting depending upon the frame size. See the following Section on Dimensions for details. The mounting surface must be sturdy and capable of bearing the weight of the unit. Fasten the unit to the mounting surface using screws or bolts of an appropriate size through the holes on the mounting brackets.

In order to allow for proper cooling and air circulation around the enclosure, maintain minimum clearance of 2 inches on the sides and 6 inches on top and bottom. The drives are cooled by fans with ventilation openings on the top and bottom of the enclosure. The air is pulled in the bottom of the enclosure and expelled out the top.

The surface below the enclosure should be of a non-flammable material and clear of obstacles.

Figure 3-2 Minimum Clearance

⚠ CAUTION: Failure to maintain adequate clearance may lead to overheating of the unit and cause damage or fire.

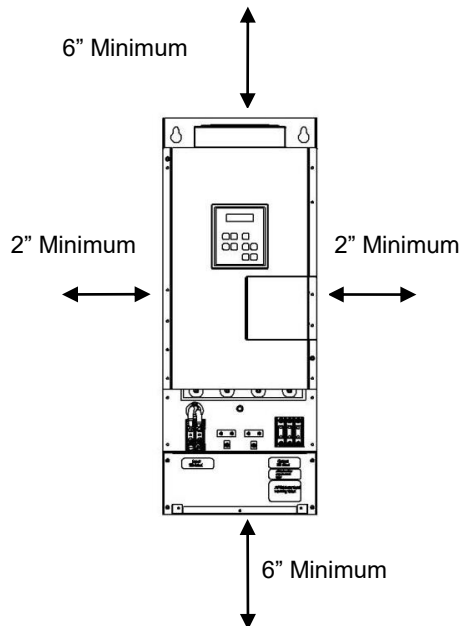

Locate the drawing of your APG Series drive frame size in Section 1.5 for determining dimensions, hole mounting location and clearance.

Integration by UL 508 Panel Shops

APG Series drives are available from the factory in two types of outdoor rainproof Type 3R enclosures. The small 3R enclosure, designated by “RQ” in the product nomenclature, is designed a stand-alone configuration with disconnects, breakers or other devices installed in separate enclosures by the end user.

Drives are also available from the factory in a large 3R enclosure, designated by “R” in the product nomenclature, with a sub-panel for installation of other components by UL 508 panel shops.

For UL 508 panel shops that prefer to mount an APG Series drive in their own enclosure, the drive is available with a mounting flange that attaches to the side of the drive by threaded inserts. The drive should be inserted into an appropriately sized hole in the rear of the panel

Figure 3-3 Mounting Flange

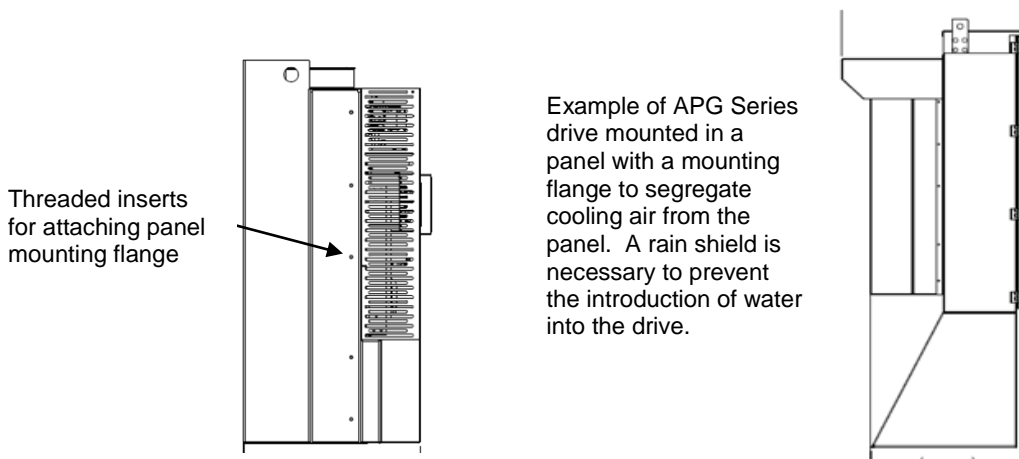









and attached to the panel by the flange. When mounted in this manner, cooling air circulated by the fan is not introduced into the cabinet.

If the drive is mounted completely inside the panel, baffles or duct must be employed to prevent the recirculation of exhaust.

⚠ CAUTION: Installation of the drive into a panel may increase back pressure created by restricting the flow of air exhausted from the fan. This may significantly reduce air flow through the heat sink, leading to higher internal temperatures and shortened component life. Additional fan(s) may be required.

3.2 General Wiring Considerations

Installations must comply with all NEC and local electrical code requirements. Please follow all warnings and directions below:

-  **WARNING:** Suitable for use in a circuit capable of delivering not more than 10 kA RMS symmetrical amperes, 240 V maximum for all models with 240V class input (refer to model nomenclature).
-  **WARNING:** Suitable for use in a circuit capable of delivering not more than 10 kA RMS symmetrical amperes, 480 V maximum for all models with 480V class input (refer to model nomenclature).
-  **WARNING:** Wire used within the motor circuit and all field wiring terminals must be rated at least 75° C.
-  **WARNING:** Use wire size suitable for Class 1 circuits.
-  **WARNING:** Input power connections should be made by a qualified electrician into a nominal 240V circuit for models with 240V input, or a nominal 480V circuit for models with 480V input, with adequate current carrying capacity. Branch circuit protection to the drive should be provided by appropriate size fuses or a 2 pole, linked circuit breaker. Circuit breaker and fuse ratings for each model are listed in Table 3-3.
-  **WARNING:** These devices are equipped with integral solid state short circuit protection. Integral solid state short circuit protection does not provide branch circuit protection. Branch circuit protection must be provided in accordance with the National Electrical Code and any additional local codes.
-  **CAUTION:** Use 600 V vinyl-sheathed wire or equivalent. The voltage drop of the leads needs to be considered in determining wire size. Voltage drop is dependent on wire length and gauge. Use Copper Or Aluminum Conductors.
-  **CAUTION:** Wires fastened to the terminal blocks shall be secured by tightening the terminal screws to a torque value listed in Table 3-2.
-  **CAUTION:** The input wire gauge must be sized to accommodate the single-phase input current, which will be significantly larger than the three-phase output current to the load.

⚠ CAUTION: Maximum wire gauge for the input terminals is listed in Table 3-2.

⚠ CAUTION: Never allow bare wire to contact the metal surfaces.

⚠ CAUTION: Never connect AC main power to the output terminals U/T1, V/T2, and W/T3.

⚠ CAUTION: Never connect AC main power or motor leads to the DC bus terminals VPOS, and VNEG.

Table 3-1 Power Terminal Descriptions

Terminal Name	Description
L1, L2	Input power terminals for single-phase input
VPOS, VNEG	Terminals to access the DC bus (optional item)
U/T1, V/T2, W/T3	Output power terminals for three-phase output
GND	Earth safety ground

Table 3-2 Field Wiring Power Terminal Specifications

Line Side Power Terminals					
Model					
APG420, APG430		APG220, APG440, APG450		APG230, APG460, APG475	
Wire Size	Torque	Wire Size	Torque	Wire Size	Torque
2 AWG	50 in. lbs	2/0-6 AWG	120 in. lbs	250 kcmil – 6 AWG	275 in. lbs
4-6 AWG	45 in. lbs	8 AWG	40 in. lbs		
8 AWG	40 in. lbs	10-14 AWG	35 in. lbs		
10-14 AWG	35 in. lbs				

Table 3-2 Field Wiring Power Terminal Specifications continued...

Load Side Power Terminals and DC Bus Terminals			
Model			
APG220, APG230, APG420, APG430, APG440, APG450		APG460, APG475	
Wire Size	Torque	Wire Size	Torque
2 AWG	50 in. lbs	2/0-6 AWG	120 in. lbs
4-6 AWG	45 in. lbs	8 AWG	40 in. lbs
8 AWG	40 in. lbs	10-14 AWG	35 in. lbs
10-14 AWG	35 in. lbs		

Table 3-3 Input Circuit Breaker and Fuse Ratings

Model	Maximum fuse rating, Class J	Maximum circuit breaker rating, amps
APG420	60 A, 600 V	60 A, 480 V
APG430	90 A, 600 V	90 A, 480 V
APG220	125 A, 600 V	125 A, 240 V
APG230	200 A, 600 V	200 A, 240 V
APG440	125 A, 600 V	125 A, 480 V
APG450	175 A, 600 V	175 A, 480 V
APG460	200 A, 600 V	200 A, 480 V
APG475	225 A, 600 V	225 A, 480 V

3.3 Control Terminals

An AP Series converter is equipped with Control Terminals that allow a number of control functions, including remote ON/OFF control, analog input and output signals, digital input and output signals, remote notification and operation of constant pressure water systems. **The correct System Configuration must be selected for proper operation of the different types of control systems! See Table 5-2, Interface Parameters.**

⚠ WARNING: All Control circuits are designed for low voltage. Do not connect external circuits with a voltage greater than the voltage specified for each Control Terminal in Table 3-4, Control Terminal Ratings and Descriptions. Disconnect all incoming sources of power, then wait 5 minutes for internal charges to dissipate before servicing the equipment.

⚠ CAUTION: The AUX1, AUX2, AUX3 and AUX4 terminals are galvanically isolated, with approximately 5V potential between them. **DO NOT** apply a voltage to the terminals. Use dry contacts only.

Figure 3-4 Control Terminal Panel



Remove the small cover on right side of front panel to access Control Terminals. For small outdoor enclosures, simply open the enclosure door.

⚠ WARNING: Risk of electric shock. De-energize the unit by disconnecting all incoming sources of power, then wait 5 minutes for internal charges to dissipate before servicing the equipment.

Control Terminals are contained on two rows of removable terminal blocks on the Master Control printed circuit board.

Remove the block for easy connection of control wires. To remove the terminal blocks, simply pull the block from mounting pins soldered into the circuit board.

⚠ CAUTION: Use care not to damage other components on the printed circuit board when removing and replacing the Control Terminal blocks.

Figure 3-5 Line Drawing of Control Terminals on MC Printed Circuit Board

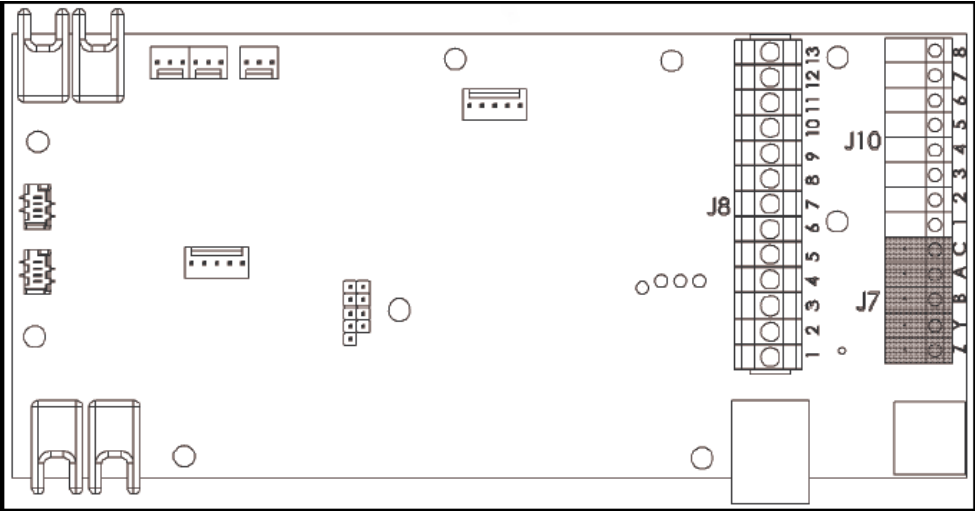

See Table 3-4, Control Terminal Ratings and Descriptions, for information on the function of Control Terminals

⚠ CAUTION: Common Terminals J8-10, J8-13, J7-C, J10-1, J10-4 are all common to one another.

Table 3-4 Control Terminal Ratings and Descriptions

Terminal Designator	Description	Rating	Comments
Terminal Block J8	J8-1 Relay 1 Common	0-30 VDC or RMS	Common terminal for J8-2 through J8-7
	J8-2 Relay 1 Normally Closed	0-30 VDC or RMS	Normally closed relay. Controlled by the conditions set in Parameter DIG 1/2/3 OUTPUT . See Table 5-5, <i>Interface Parameters</i> , for instructions on programming this relay.
	J8-3 Relay 1 Normally Open	0-30 VDC or RMS	Normally open relay. Controlled by the conditions set in Parameter DIG 1/2/3 OUTPUT . See Table 5-5, <i>Interface Parameters</i> , for instructions on programming this relay.

Terminal Block J8	J8-4	Relay 2 Normally Open Terminal 1	0-30 VDC or RMS	Normally open relay. Controlled by the conditions set in Parameter DIG 4/5 OUTPUT . See Table 5-5, <i>Interface Parameters</i> , for instructions on programming this relay.
	J8-5	Relay 2 Normally Open Terminal 2	0-30 VDC or RMS	
	J8-6	Relay 3 Normally Open Terminal 1	0-30 VDC or RMS	Normally open relay. Controlled by the conditions set in Parameter DIG 6/7 OUTPUT . See Table 5-5, <i>Interface Parameters</i> , for instructions on programming this relay.
	J8-7	Relay 3 Normally Open Terminal 2	0-30 VDC or RMS	
	J8-8	AUX 1	10 mA DC, > 30 kOhm = OFF, <100 Ohm = ON	Remote START/STOP terminal 1. Dry contact closure between the terminals will start the drive and connected load. Both AUX1 and AUX2 must be closed for the motor to run. In a digital CP system, the primary pressure switch is attached to AUX1.
	J8-9	AUX 2	10 mA DC, > 30 kOhm = OFF, <100 Ohm = ON	Remote START/STOP terminal 2. Dry contact closure between the terminals will start the drive and connected load. Both AUX1 and AUX2 must be closed for the motor to run. In digital and analog CP systems, the emergency over-pressure limit switch is attached to AUX2.
	J8-10	Common		Common terminal for AUX1 and AUX2. This terminal is also common to terminals J8-13, J7-C, J10-1, J10-4.
	J8-11	AUX 3	10 mA DC, > 30 kOhm = OFF, <100 Ohm = ON	Programmable digital input controlled by System Configuration setting. See Section 6.3, <i>System Configuration</i> , for details.
	J8-12	AUX 4	10 mA DC, > 30 kOhm = OFF, <100 Ohm = ON	Programmable digital input controlled by System Configuration setting. See Section 6.3, <i>System Configuration</i> , for details.

Installation

	J8-13	Common		Common Terminal for AUX3 and AUX4. This terminal is also common to terminals J8-10, J7-C, J10-1, J10-4.
Terminal Block J7	J7-Z	MODBUS	Transmit	MODBUS protocol
	J7-Y	MODBUS	Transmit	MODBUS protocol
	J7-B	MODBUS	Receive	MODBUS protocol
	J7-A	MODBUS	Receive	MODBUS protocol
	J7-C	MODBUS		MODBUS Common Terminal. This terminal is also common to terminals J8-10, J8-13, J10-1, J10-4.
Terminal Block J10	J10-1	Common		Common Terminal for 0-5 VDC analog output terminals 2 & 3. This terminal is also common to terminals J8-10, J8-13, J7-C, J10-4.
	J10-2	Analog Out 2	0-5 VDC	Analog signal to indicate motor torque. 2.5V = zero motor torque, 5V = rated motor torque positive, 0V = rated motor torque negative.
	J10-3	Analog Out 1	0-5 VDC	Analog signal to indicate motor speed. Signal is relative to scale of frequency from 0 Hz to Maximum Frequency as set in Adjustable Parameter menu (factory default 60 Hz). 4V equals rated motor speed.
	J10-4	Common		Common for 0-5 VDC input and output on Terminals J10-5 & J10-6. This terminal is also common to terminals J8-10, J8-13, J7-C, J10-1.
	J10-5	0-5 VDC In	0-5 VDC	Analog input for motor speed control for 0-5 VDC external source. Speed is relative to scale of signal from 0 Hz to Maximum Frequency as set in Adjustable Parameter menu (factory default 60 Hz). See Figure 3.4
	J10-6	0-5 VDC Out	0-5 VDC	5 VDC supply to provide power to analog voltage transducers. Connect the positive lead to Terminal 6. Connect the negative lead to Terminal 4. See Figure 3.5.
	J10-7	4-20 mA Negative	4-20 mA	Analog transducer input to control motor speed. Analog input must be activated with keypad. Refer to Section 5.2, <i>Controlling Motor Speed with Analog Input</i> for detailed instructions. See Figure 3.6 for a connection diagram.
	J10-8	4-20 mA Positive	4-20 mA	

0-5 VDC Analog Input

Follow these steps to connect a 0-5 VDC source to analog input:

1. Using the keypad, set the value of parameter **SYSTEM CONFIG** to 1. See Table 5-5, *Interface Parameters*, for details.
2. Using the keypad, set the value of parameter **INPUT MODE** to 0. See Table 5-5, *Interface Parameters*, for details.
3. Connect the negative lead of the source to Common Terminal # 4 on Terminal Block J10
4. Connect the positive lead of the source to terminal # 5 on Terminal Block 10.

Figure 3-6 Connection Diagram for External 0-5VDC Source to Analog Input

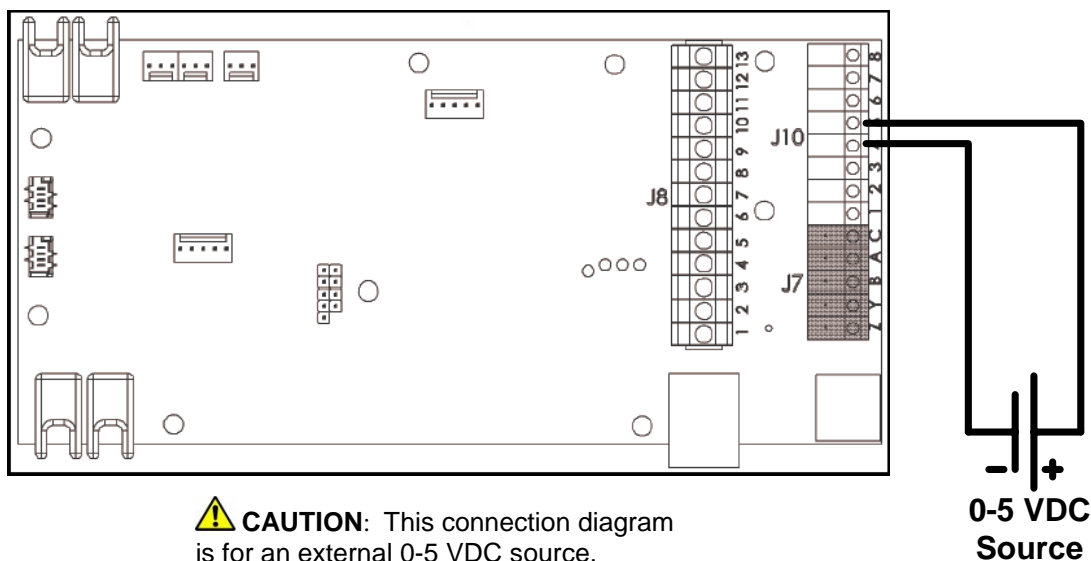

0-5 VDC Transducer (Potentiometer)

Follow these steps to connect a 0-5 VDC transducer to analog input:

1. Using the keypad, set the value of parameter **SYSTEM CONFIG** to 1. See Table 5-5, *Interface Parameters*, for details.
2. Using the keypad, set the value of parameter **INPUT MODE** to 0. See Table 5-5, *Interface Parameters*, for details.
3. Connect the negative lead of the transducer to Common Terminal # 4 on Terminal Block J10
4. Connect the analog output lead of the transducer to terminal # 5 on Terminal Block J10.
5. Connect the positive lead of the transducer to terminal # 6 on Terminal Block J10.

⚠ CAUTION: The resistance value of the transducer must be from 5,000 ohms to 20,000 ohms. Resistance below 5,000 ohms will produce a high current in the circuit and may damage components in the circuit.

Figure 3-7 Connection Diagram for 0-5VDC Transducer to Analog Input

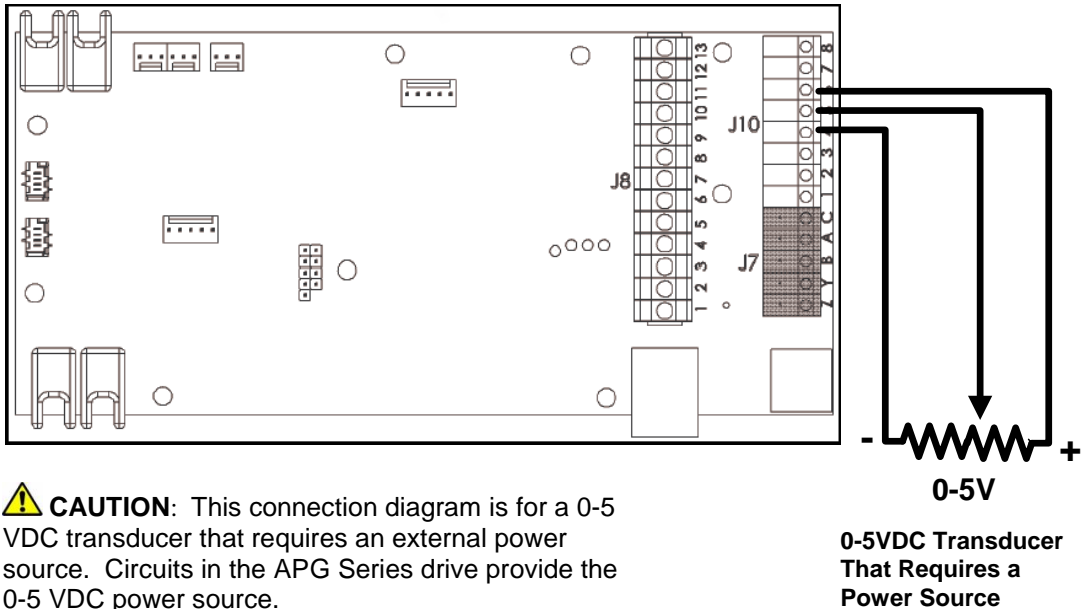

4-20 mA Analog Transducer

Follow these steps to connect a 4-20 mA transducer:

1. Using the keypad, set the value of parameter **SYSTEM CONFIG** to 1 for proportional motor speed control, or 2 for analog constant pressure. See Table 5-5, *Interface Parameters*, for details.
2. Using the keypad, set the value of parameter **INPUT MODE** to 1. See Table 5-5, *Interface Parameters*, for details.
3. Connect the positive lead of the transducer to terminal # 8 on Terminal Block J10.
4. Connect the negative lead of the transducer to terminal # 7 on Terminal Block J10.

⚠ CAUTION: The settings detailed above with the parameter **SYSTEM CONFIG** set at 1 results in linear speed control of the motor based on the analog signal from the transducer. This setting will not provide control of a constant pressure water system. For constant pressure control with 4-20mA transducer, **SYSTEM CONFIG** must be set at 2. See Section 7, *Constant Pressure Water Systems*, for more information.

Figure 3-8 Connections for 4-20 mA Analog Transducer

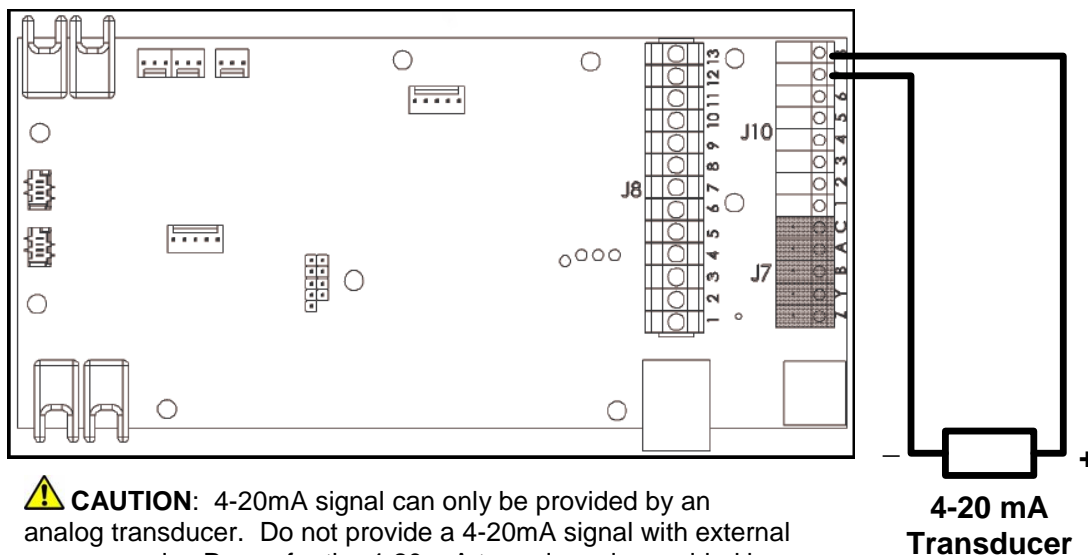

3.4 Installing Power Cables

⚠ CAUTION: Continuous metal conduit should be used on all power cables, both line and load side, to reduce conducted and emitted radiation of electromagnetic interference (EMI). The conduit must be securely grounded to the enclosure of the drive and the motor case.

When it is not practical to use continuous metal conduit, special shielded cables can be used. The shielded cable should be constructed with symmetrical conductors and a copper or aluminum shield covered with an insulating jacket. A good shield results in lower EMI interference and lower motor bearing currents.

Power cables should enter the drive enclosure only through the bottom of the wire cavity which is located below the power terminals. Knockouts are not provided in the enclosure. Appropriately sized conduit openings must be created with a punch.

Do not install line-side power cables in the same conduit or cable tray with load side power cables. Also, do not route control cables through the same conduit or cable tray as power cables. A separate conduit entrance for control cables is provided on the right side of the drive near the Control Terminals. This avoids the need for control cables to be routed through the high EMI environment of the drive enclosure.

Figure 3-9 Routing Power Cables

⚠ CAUTION: When possible, avoid routing control cables and power cables in close proximity to avoid coupling EMI onto control cables.

⚠ CAUTION: Power cable conduit openings in the enclosure should be made only in the bottom of the enclosure.

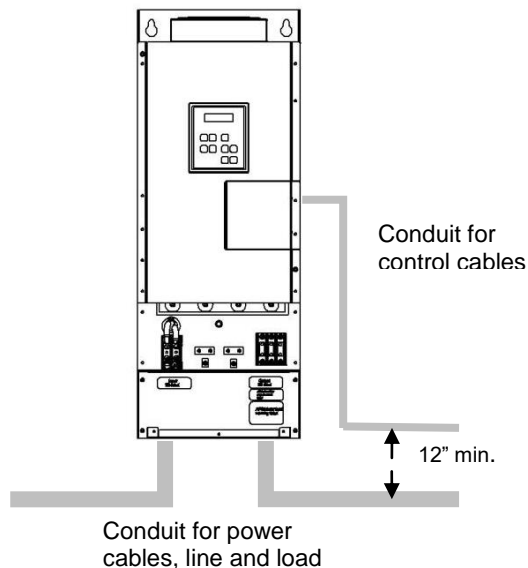

Operation of an APG Series drive is simple and straightforward after completion of physical installation and wiring. Before operating the motor load, several basic settings and procedures must be completed. If desired, extensive features for special operating conditions and for protection of the motor load are available through the keypad.

A power-up test should be performed before the unit and its load are placed in service. Refer to Section 6.1, *Commissioning the Unit*. Before initial power up, it is advisable to become familiar with setting motor overload protection, setting system configuration, and with basic operation of the optional keypad and display.

4.1 Using the Keypad and Display

An APG Series drive is capable of many advanced, easy to use features that allow the user to protect the motor load from damage, monitor load conditions, log motor run time, trouble shoot the system and more. The keypad is easy to use and understand, with 32 character text messages and an intuitive interface specifically tailored for pumping applications.

Figure 4-1 Keypad & Text Display

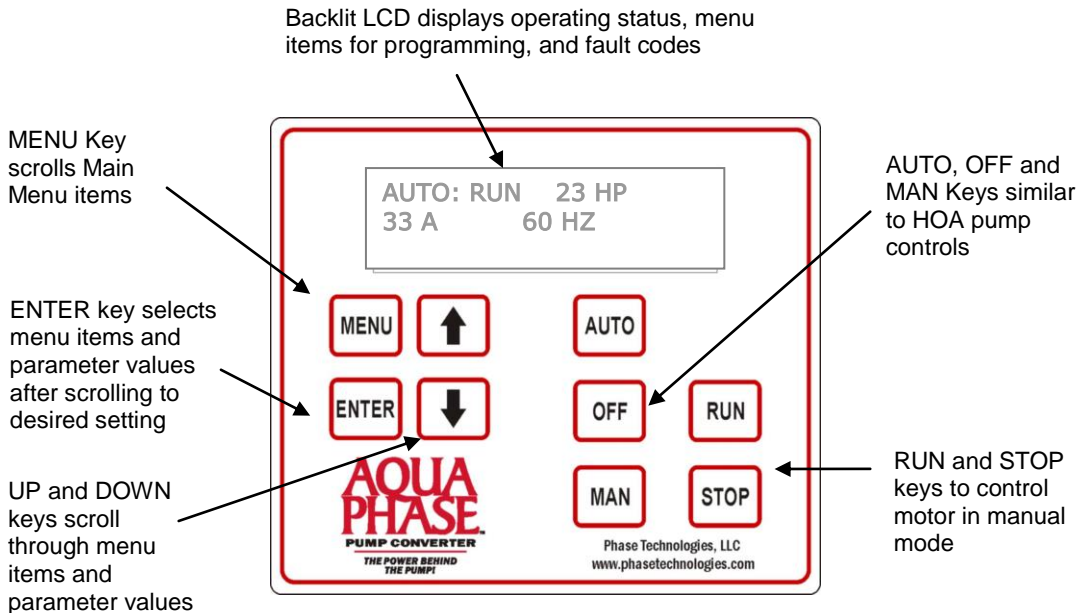

Auto-Dimming Display

The backlit LCD display is designed to enter a sleep mode and dim the display after 5 minutes of inactivity on the keypad. The display can be awakened by touching any key on the keypad. When the display is in sleep mode, touching any key results only in awakening the display. Specific key function will not return until the display is lit.



Default Display Mode

After two minutes of keypad inactivity, the display will revert to the default display mode, which indicates either AUTO, MANUAL, or OFF mode and the status of the AUX1 and AUX2 remote switch circuits. The default display also indicates the output horsepower (HP), output current in amps (A) and output frequency in Hz.

Keypad Display Messages

Several messages will appear on the display when the unit is initially energized. When the unit has completed its start-up routine, the default display indicating the status of the OFF, AUTO, MAN mode will appear. Start-up display messages are detailed in Table 4-1 below.

Table 4-1 Display of Operating Modes

DISPLAY MESSAGE	DESCRIPTION
AUTO	<p>In factory default state the default start-up mode is OFF. The adjustable parameter, <i>ENABLE RESTARTS</i>, must be set to the proper value to allow automatic starts. See Table 5-1, Operating Parameters for details.</p> <p> CAUTION: In AUTO mode, the motor load will automatically run if both AUX1 and AUX2 remote switches are closed. To stop the motor, push MAN (manual) or OFF, or open AUX1 or AUX2. The RUN and STOP keys only work when in MAN mode</p>
MANUAL	<p>Unit is in MANUAL mode. Activate MANUAL mode by pushing the MAN key. In MANUAL mode the motor load is controlled by using the RUN and STOP keys, which will override the AUX1 and AUX2 remote switches.</p> <p> CAUTION: Operating the system in MAN mode on the keypad overrides signals from the pressures switches. Operating the system in this mode may lead to dangerous pressures in closed plumbing systems</p>
OFF	<p>In factory default state the default start-up mode is OFF. The adjustable parameter, <i>ENABLE RESTARTS</i>, must be set to the proper value to allow automatic starts. Pressing the OFF key during operation will stop the motor load. To start the motor, revert to either AUTO mode or MANUAL mode. Certain faults can also be cleared by simultaneously pressing the up-arrow and the down-arrow key.</p>

4.2 Keypad Main Menu Items

Main Menu items are accessed by pressing MENU on the keypad. Press MENU again to scroll through the Main Menu items. Press ENTER to view or edit a Main Menu item.

Figure 4-4 Navigating Main Menu Items

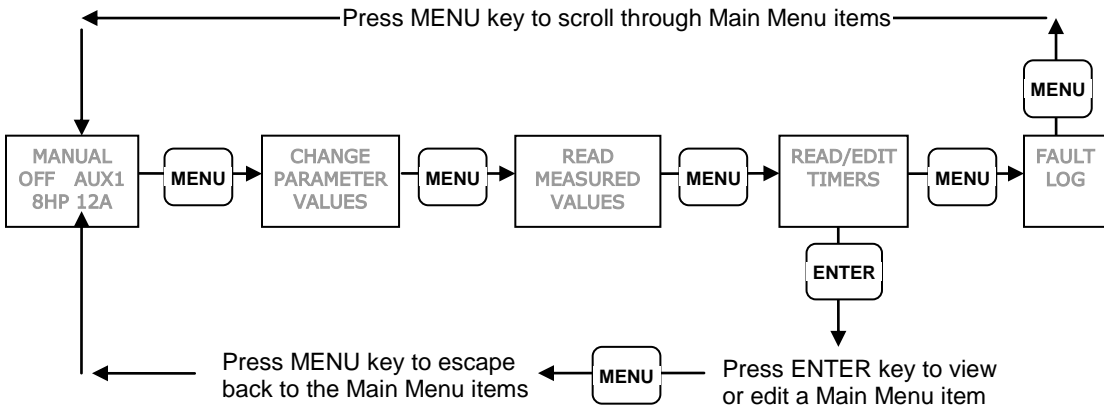

Table 4-2 Main Menu Items

DISPLAY MESSAGE	DESCRIPTION
MANUAL/OFF/AUTO AUX1 AUX2 HP, A, HZ	Display indicates either AUTO, MANUAL, or OFF mode, the status of the AUX1 and AUX2 switch circuits, and other operating parameters. After 2 minutes of keypad inactivity, the display will revert to this mode.
CHANGE PARAMETER VALUES	Allows the user to set values for functions such as motor overload settings, dry well condition, time to restart after a fault, etc.
READ MEASURED VALUES	Displays measured values such as output current, input voltage, load power factor, etc.
READ/EDIT TIMERS	Records motor run time and drive on time
FAULT LOG	Records the number of times a particular fault has occurred.
ENTER AUTO TUNING MODE	Press ENTER to bring Auto Tune menu on display. Press ENTER again to begin auto tuning procedure for vector control.
CLEAR MEMORY	Press ENTER to bring up CLEAR MEMORY menu. Use arrow keys to select RESET TIMERS or CLEAR FAULTS. Clearing faults will clear ALL faults in the log. Press ENTER to clear timers or faults.

Read Measured Values

The display can provide a variety of measured values related to the performance of the drive and its load, such as currents, horsepower, and power factor. To read measured values:

1. Press the MENU key to scroll through menu items until **READ MEASURED VALUES** appears on the display.
2. Press ENTER to access this menu item.
3. Use the up and down arrow keys to scroll through the various values that you wish to read.

Figure 4-5 Read Measured Values

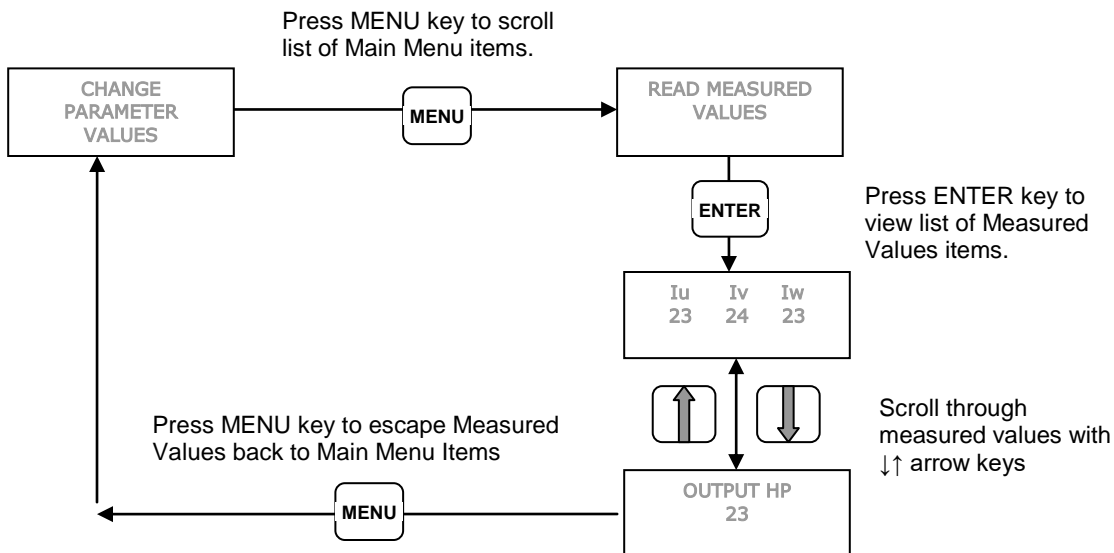

Programming Tip

The measured values **OUTPUT HP**, **OUTPUT KWATTS**, **OUTPUT KVA** and **OUTPUT PF** can be displayed as either positive or negative values when the drive is operating the motor in sensorless vector torque control mode. If any of these values are negative it indicates that the motor is producing regenerative power.

Table 4-3 Measured Values

DISPLAY MESSAGE	DESCRIPTION OF MEASURED VALUE
Iu Iv Iw	Three-phase currents on the output
OUTPUT HP	Output measured in horse power
OUTPUT KWATTS	Output measured in kilowatts
OUTPUT KVA	Output measured in KVA
OUTPUT PF	Power factor of the motor load
BUS CAP VOLTAGE	Voltage of the DC bus
INPUT VOLTAGE	Input voltage AC
INPUT CURRENT	Input current in amps
AUX1 AUX2	ON/OFF status of the remote switch circuits AUX1 and AUX2
AUX3 AUX4	ON/OFF status of the remote switch circuits AUX3 and AUX4
STATUS	Reserved
TROUBLESHOOTING	Reserved for factory technicians
FREQUENCY	Output frequency in Hz
CURRENT UNBALANC	Current unbalance between the three output phases as a percentage
V 5VDC IN	Measures the 0-5 VDC analog control voltage between Control Terminals J10-5 and J10-4
I 20MA IN	Measures 4-20 mA analog control current on Control Terminals J10-7 and J10-8
MC VERSION NUM	Displays the version of firmware on the Master Controller (MC) board
INPUT VERS NUM	Displays the version of firmware on the Input Controller board
OUTPUT VERS NUM	Displays the version of firmware on the Output Controller board
KEYPAD VERS NUM	Displays the version of firmware on the User Interface (keypad) board
MODEL NUMBER	Displays the APG Series product model number
TIME UNTIL START	Displays a timer that counts down the time left to restart when the drive is in an automatic restart mode

Read and Edit Timers

The timer function records the motor run time in hours, and the time the drive has been energized. There are two timers for each function, one which can be reset, and one permanent. To view and reset the timers:

1. Press the MENU key to scroll through menu items until **READ/EDIT TIMERS** appears on the display.
2. Press ENTER to enter this menu item.
3. Use the up and down arrows to scroll through the clock functions.
4. To reset the clock timers, navigate to the Main Menu item, **CLEAR MEMORY**, use arrow keys to select **RESET TIMERS**, then press ENTER

Figure 4-6 Read/Edit Timers

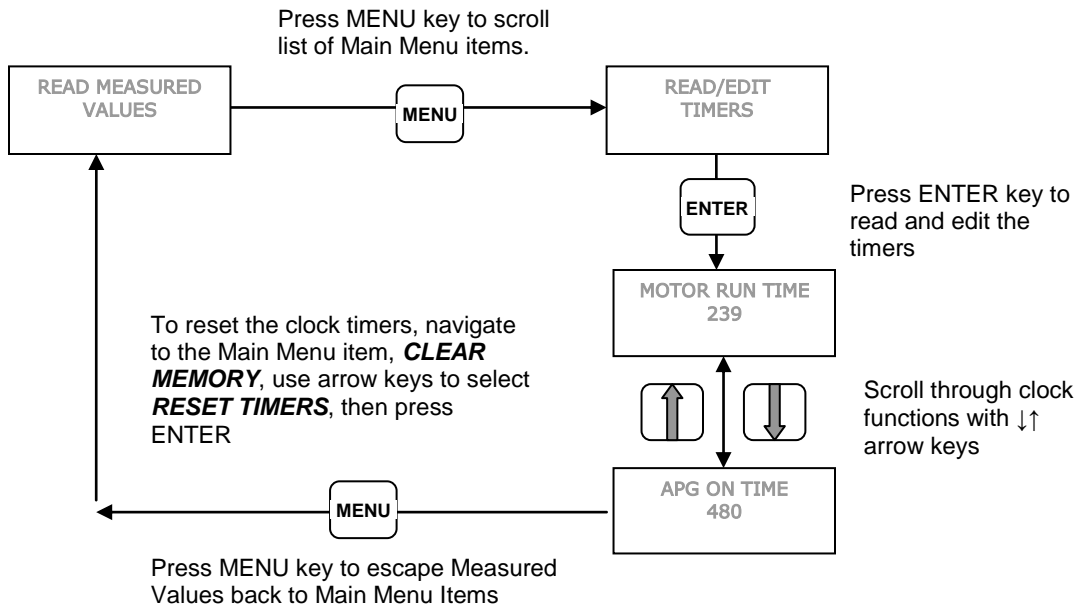

Table 4-5 Timers

TIMER	DESCRIPTION
MOTOR RUN TIME	Logs motor run time in hours. To reset, press ENTER, then both arrow keys for 3 seconds.
APG ON TIME	Logs time in hours the AP Series unit is energized To reset, press ENTER, then both arrow keys for 3 seconds.
ALL MOTOR HOURS	Logs total motor run time. Not resettable.
ALL APG HOURS	Logs total time the AP Series unit is energized. Not resettable.



Programming Tip

To reset the timers, navigate to the Main Menu item, **CLEAR MEMORY**, use arrow keys to select **RESET TIMERS**, then press ENTER

Fault Log

The Fault Log records the number of times a particular fault has occurred. For instance, in a remote well pump application, it might be useful to know how many times the unit has tripped due to dry well since the last visit to the site. To view the Fault Log:

1. Press the MENU key to scroll through menu items until **FAULT LOG** appears on the display.
2. Press ENTER to access this menu item.
3. Use the up and down arrows to scroll through the fault functions.
4. The fault will appear on the first row of the display, followed by the number of times that fault has occurred.
5. To clear faults, navigate to the Main Menu item, **CLEAR MEMORY**, use arrow keys to select **CLEAR FAULTS**, then press ENTER

CAUTION: Clearing faults through the **CLEAR MEMORY** menu will clear ALL faults in the log!

Figure 4-7 Fault Log

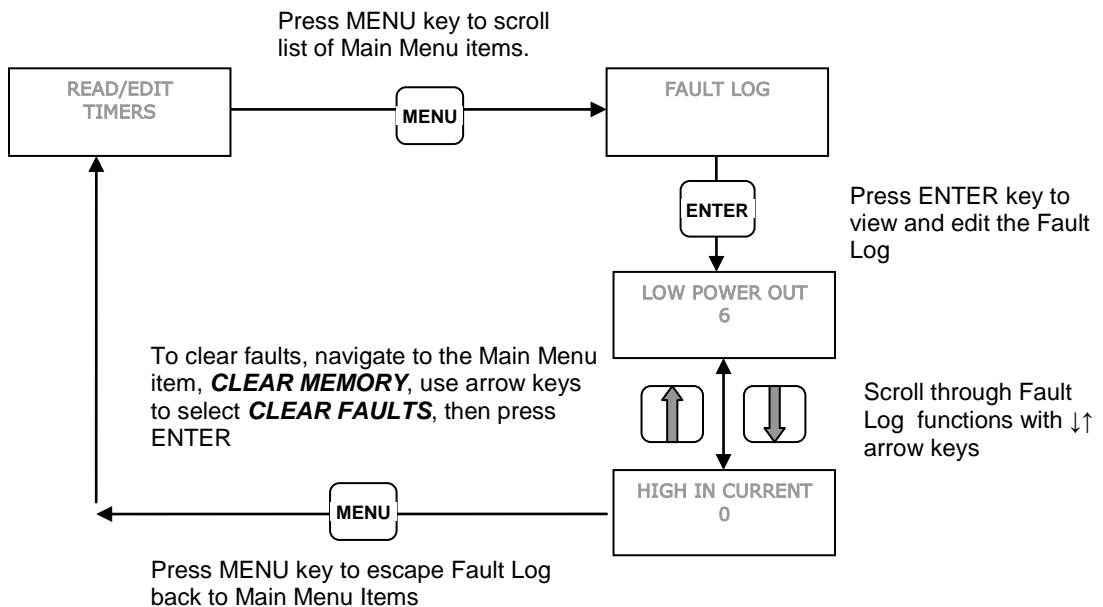

See Section 9.1 *Status Indicators and Fault Codes*, for a complete listing of fault codes.

Auto Tuning Mode

This Main Menu item allows for basic automatic tuning of motor parameters when the drive is operating in sensorless vector torque control mode. Refer to Section 6.6, *Sensorless Vector Torque Control*, and Table 5-4, *Torque Control Parameters*, for more information on using this feature.

⚠ CAUTION: Before operating the drive in torque control mode, be certain to enter motor nameplate data including rated HP, rated current and rated RPM. These parameters can be set by navigating to the Main Menu item **CHANGE PARAMETER VALUES > TORQUE CONTROL PARAMETERS**. Failure to properly set these parameters will result in faulty operation of the motor and potentially dangerous conditions.

Figure 4-8 Auto Tuning Mode

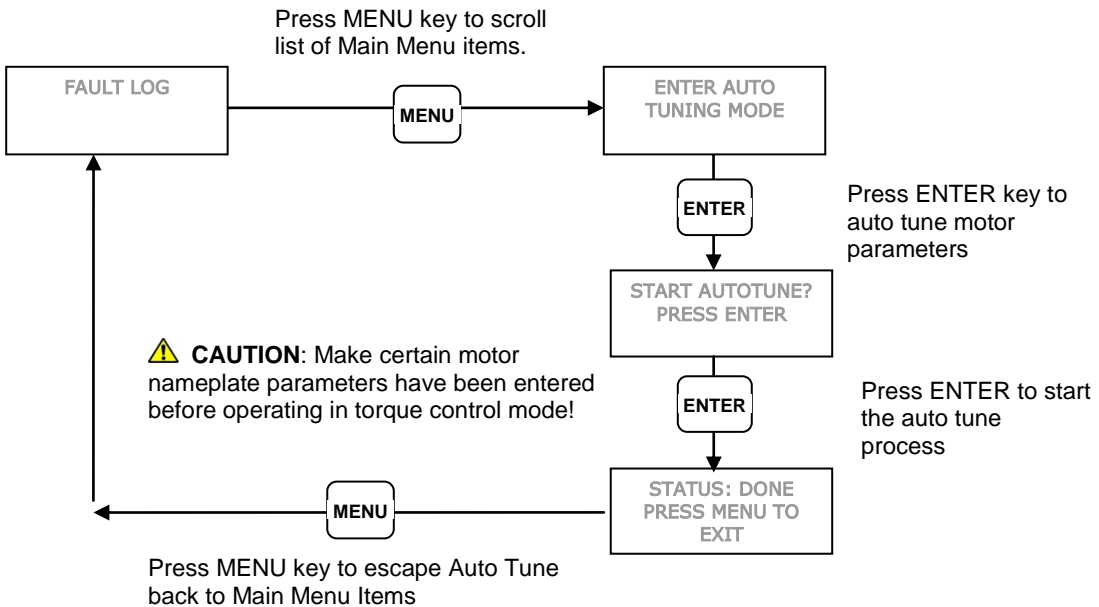

⚠ CAUTION: Before operating the drive in torque control mode it is highly recommended that you read Section 6.6, *Sensorless Vector Torque Control* for a complete understanding of torque control operation and parameters.

Change Parameter Values

APG Series drives are equipped with advanced features to fit a wide range of applications. However, unlike most VFDs that are designed for industrial automation, the APG user interface is tailored specifically for pumping and wind power applications, making it simple and intuitive to use.

The Main Menu item, **CHANGE PARAMETER VALUES**, leads to several sub-menus that contain adjustable operating parameters. These parameters provide basic functions such as motor overload protection and advanced features that allow you to customize operation of the drive to fit your application.

The following Section 5, *Adjustable Parameters*, contains a complete list of the parameters along with a description of their function and instructions on setting them.

5.1 Changing Parameter Values



Programming Tip

There may be a slight delay in displaying a new parameter value when setting adjustable parameters. After the new setting is selected, the communication between the keypad and the main controller may take several seconds.



WARNING: When the drive is set to automatically restart after a trip or fault, the main output terminals can energize and the load can start without warning, exposing the user to risk of serious injury. Make certain the input is de-energized or controls to the load are OFF before approaching the equipment. The unit can be programmed to automatically restart after certain faults. The factory default setting does not allow automatic restart. Use caution if automatic restart is allowed for any fault.

The Change Parameter Values function allows the user to set values for a variety of functions including motor overload settings, number of restarts after a fault, ramp time, maximum frequency, and more. To change parameter values:

1. Press the MENU key to scroll through menu items until **CHANGE PARAMETER VALUES** appears on the display.
2. Press ENTER to access this menu item.
3. There are six sub-menu items under **CHANGE PARAMETER VALUES**. Use the up and down arrows to scroll through the sub-menu to find the item desired, then press ENTER. See Tables 5-1 through 5-6, for a list of parameters with a description.
4. Use the up and down arrow keys to scroll to the parameter you want to set, press ENTER, then use the up and down arrows to select a new value for that parameter.
5. When the value you want appears on the display, press ENTER to select that value.
6. To escape the parameter without selecting or resetting the value, press the MENU key, which will return you to the list of parameters.



Programming Tip

Press the ENTER key to move to lower levels of the menu outline or to save a new parameter value. Press the MENU key to move to higher levels in the menu outline or to escape a parameter setting without changing the value.

Figure 5-1 Changing Parameter Values

Press MENU key to scroll through Main Menu items.

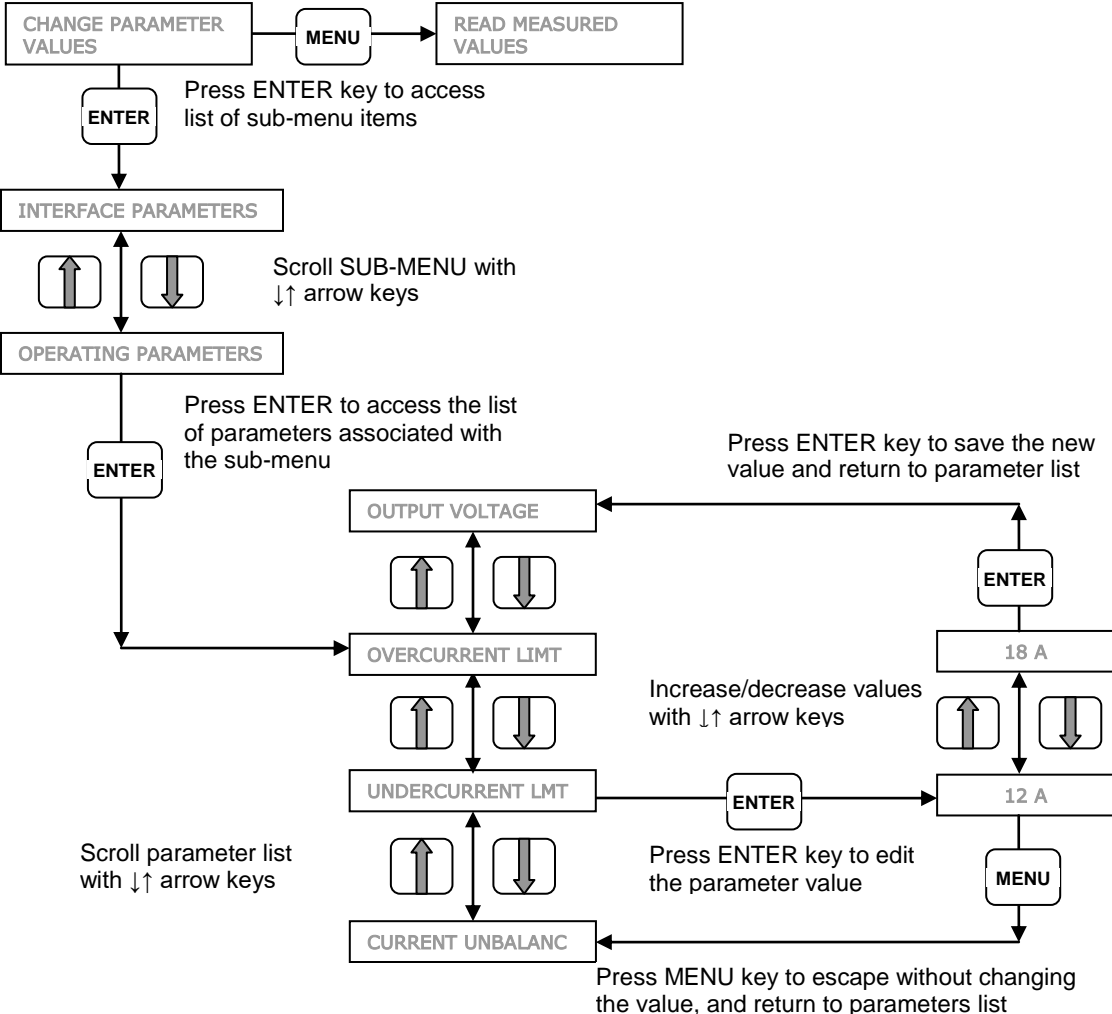

Restore Default Parameter Settings

To restore **ALL** adjustable parameters to their default value, press and hold the MENU, ENTER, ↓, ↑ keys at once and hold for three seconds.



Programming Tip

Make sure to press all four keys at once. The display will read “RESETTING”. Do not release until the display reads “DONE”. If this reset is done while the motor is running, the drive will stop.

⚠ CAUTION: Holding all four of these keys down will reset **ALL** programmable parameters to the default value. To reset an individual parameter to its default value, you must refer to the appropriate Table of Adjustable Parameters, find the default value, re-enter that value and save it. See Tables 5-1 through 5-6 for a complete list of adjustable parameters, their description and default/minimum/maximum values.

5.1.2 Reset the Fault Counter

The drive can be programmed to automatically restart after certain faults, and the user can also select the number of automatic restarts allowed before the unit will remain OFF after a fault.

To clear the fault counter and start counting the number of faults from zero again, the Fault Counter must be cleared. The Fault Counter can be cleared in two ways:

1. Cycle the input power to the drive OFF/ON
2. Simultaneously push the up-arrow and down-arrow keys

⚠ CAUTION: Resetting the Fault Counter will reset to zero the count for **ALL** resettable faults. Do not confuse the Fault Counter with the Fault Log. The Fault Log counts all faults and can only be reset by navigating the Main Menu item **CLEAR MEMORY**. Clearing the Fault Log will not reset the Fault Counter.

⚠ CAUTION: Simultaneously pushing the up-arrow and down-arrow keys or cycling input power OFF/ON will reset the Fault Counter. When this happens the drive will start counting the number of restarts for a particular fault from zero. The number of restarts allowed for resettable faults is set in the AUTO RESTART PARAMETERS menu. A list of these parameters and their description is found in Table 5-2.

Adjustable Parameters

Table 5-1 Operating Parameters

DISPLAY MESSAGE	DESCRIPTION	DEFAULT/MIN /MAX VALUE
GND FAULT DETECT	Detects a fault between any output line and earth. Sensitivity to fault detection is adjustable to avoid nuisance trips. Parameter may be disabled.	8/disabled/9
OUTPUT VOLTAGE	Phase-to-phase output voltage, 240V input models	480/380/500
	Phase-to-phase output voltage, 480V input models	480/440/500
CURRENT UNBALANC	% current unbalance on output phases, NEMA MG1	100/0/100
MINIMUM FREQ	Minimum output frequency allowed in any steady state condition. Motor accelerates from zero to minimum frequency in 1 second and decelerates from minimum frequency to zero in 1 second. Important in protecting the thrust bearing in submersible pumps.	30/5/120
START UP RAMP	Time in seconds from MIN FREQUENCY to MAX FREQUENCY. Ramp speed is linear	8/1/120
SHUTDOWN RAMP	Time in seconds from MAX FREQUENCY to MIN FREQUENCY. Ramp time is linear.	8/1/120
MAX FREQUENCY	Maximum frequency allowed, or target frequency at start-up ramp. This parameter value cannot be set lower than MINIMUM FREQ.	60/5/120
ENABLE RESTARTS	This parameter controls the ability of the drive to automatically restart after a fault and to initialize in AUTO mode. 0 = no auto restarts and unit will initialize in OFF mode 1 = Auto mode on initialization and auto restarts allowed	0/0/1
TROUBLESHOOTING	Factory assisted use only. Contact manufacturer.	0/0/10
BOOST VOLTAGE	Reserved	0/0/100
BOOST FREQUENCY	Reserved	0/0/100
OVERCURRENT LIMIT	Setting for motor overload protection, Trip Class 10 curve.	APGx20: 30/3/33
		APGx30: 46/3/48
		APG440: 60/6/66
		APG450: 76/6/80
		APG460: 92/6/96
		APG475: 107/6/118

Adjustable Parameters

DISPLAY MESSAGE	DESCRIPTION	DEFAULT/MIN /MAX VALUE
UNDERCURRENT	Unit shuts down when output current goes below the set value (dry well protection). To use this function for dry well protection, set MINIMUM POWER to zero.	APGx20: 0/0/30
		APGx30: 0/0/46
		APG440: 0/0/60
		APG450: 0/0/76
		APG460: 0/0/92
		APG475: 0/0/115
MIN POWER (KW)	Unit shuts down when output measured in KW goes below the set value (dry well protection). Generally more accurate than undercurrent. To use this feature for dry well protection, set UNDERCURRENT LIM to zero.	APGx20: 0/0/20
		APGx30: 0/0/30
		APG440: 0/0/40
		APG450: 0/0/50
		APG460: 0/0/60
APG475: 0/0/75		
SWITCHING FREQ	Switching frequency of the IGBT inverter module	2000/2000/5000
REVERSE ROTATION	Reverses motor direction by changing sequence of output phase rotation. 0 = Standard phase sequence (ABC) 1 = Reverse phase sequence (ACB)	0/0/1
COAST TO STOP	Selects between coast to stop or ramp to stop. Ramp profile is controlled by parameter SHUTDOWN RAMP. 0 = ramp to stop 1 = coast to stop	0/0/1

Adjustable Parameters

Table 5-2 Auto Restart Parameters



Programming Tip: The parameter ENABLE RESTARTS in the Operating Parameters menu must be enabled for automatic restarts. Refer to Table 5-1.

DISPLAY MESSAGE	DESCRIPTION	DEFAULT/MIN /MAX VALUE
RESTART DELAY 1	Delay in seconds before unit restarts after a trip due to: <ul style="list-style-type: none"> • Over-current due to motor overload Trip Class • Instantaneous over-current 	300/0/9999
RESTART DELAY 2	Delay in seconds before unit restarts after a trip due to: <ul style="list-style-type: none"> • DC bus over voltage • Under current (dry well) • Single-phasing • Current imbalance • Minimum power (dry well) 	300/0/9999
RESTARTS DRY WELL	# automatic restarts allowed due to under current and minimum power trip (see Note 1)	0/0/9999
RESTARTS CUR IMB	# automatic restarts allowed due to current imbalance trip (see Note 1)	0/0/9999
RESTARTS SING PH	# automatic restarts allowed due to single phasing trip (see Note 1) To disable single phase protection, set number of restarts to 99	0/0/9999
RESTARTS CUR OVL	# automatic restarts allowed due to overload current trip on the load and line module (see Note 1)	0/0/9999
DRY WELL DELAY	Time in seconds dry well is allowed before unit trips	4/0/9999
START UP DELAY	Anti-cycling feature. Delay in seconds before motor restarts after an input power OFF/ON cycle.	0/0/9999
RESTARTS UNDER V	# automatic restarts allowed due to low input voltage trip (see Note 1)	0/0/9999
RESTARTS OVER V	# automatic restarts allowed due to high input voltage trip (see Note 1)	0/0/9999
RESTART DELAY3	Delay in seconds before unit restarts after a trip due to: <ul style="list-style-type: none"> • Input over voltage • Input under voltage 	300/0/9999
RESTARTS BUS OV	# restarts allowed due to DC bus overvoltage (see Note 1)	0/0/9999

Note 1: The Fault Counter must be cleared to begin counting the number of restarts from zero. The Fault Counter can be cleared in two ways:

1. Cycle the input power to the drive OFF/ON
2. Push the OFF key twice (double-click)

See Section 5.1.2, *Reset the Fault Counter*, for complete information.

Table 5-3 Constant Pressure Parameters

Adjustable Parameters

DISPLAY MESSAGE	DESCRIPTION	DEFAULT/MIN /MAX VALUE
TRANSDUCER SETPT	As a %. For analog CP system only. This sets the level at which the pressure will be controlled. It is a percentage of the full-scale range of the pressure transducer, i.e. if the setpoint is 50% and the pressure transducer has a full-scale range of 150psi, then the control pressure will be 75psi.	50/0/100
CONTROLLER GAIN	Multiplier for the analog error signal in an analog constant pressure system. The default SIMPLE MODE setting minimizes the problem that commonly occurs in analog CP systems where the pressure control is not accurate when the pump is running at low speed. When gain is set to a value less than 1 the keypad displays SIMPLE MODE and the controller switches to an algorithm which does not require a gain setting.	SIMPLE MODE/1/60
DUPLEX PRES DROP	As a % of the full-scale transducer range. For analog CP system only. Sets the drop in pressure that must occur before the Slave unit is turned on to assist the Master.	5/0/30
T OFF	In seconds. Used to prevent short cycling in CP systems. If the motor was off during the last cycle for a period greater than TOFF, the minimum on time of the motor is T1ON. If the motor was off for a period less than TOFF, the minimum on time of the motor is T2ON. Default values give a minimum cycle time of about 1 minute.	30/0/1000
T1 ON	In seconds. See T OFF above. T1ON should be set to be less than T2ON.	30/0/1000
T2 ON	In seconds. See T OFF above. T1ON should be set to be less than T2ON.	60/0/1000
SHUTOFF PMIN	As a % of RATED HORSEPOWER. Prevents short cycling in CP mode. When power to the motor drops below PMIN times RATED HORSEPOWER, the motor will turn off.	25/0/100
BOOST AMOUNT	As a % of Maximum Frequency for digital CP systems, or as a % of the full-scale transducer pressure range for analog CP systems. In CP systems, this boosts the pressure or motor speed a given %, and for a fixed time of 5 seconds before the motor shuts down.	5/0/100
PRECHARGE FREQ	In Hz. Sets the maximum frequency applied to the motor during the pre-charge interval.	30/1/120
PRECHARGE TIME	In seconds. Sets the maximum time for pre-charge regardless of any sensor inputs. A setting of zero disables the pre-charge mode.	0/0/30000

Adjustable Parameters

DISPLAY MESSAGE	DESCRIPTION	DEFAULT/MIN /MAX VALUE
PRECHRG SETPOINT	As a %. Used only for analog CP systems. Sets pressure as % of transducer full-scale range. Pre-charge will be terminated when pressure reaches this set point. Should be set less than TRANSDUCER SETPT.	20/0/100
DUPLEX CYC TIME	In minutes. In a duplex system this determines the maximum time interval that either the Master unit or the Slave unit will be the primary pump. A setting of zero disables the Duplex mode. DUPLEX CYC TIME should be set only on the Master unit. The Slave unit must <u>always</u> have a DUPLEX CYC TIME setting of zero.	0/0/9999

Adjustable Parameters

Table 5-4 Torque Control Parameters

DISPLAY MESSAGE	DESCRIPTION	DEFAULT/MIN /MAX VALUE
SV CONTROL	Selects for either V/F control or sensorless vector control. 0 = V/F control 1 = SV Control	0/0/1
RATED RPM	Motor name plate RPM	1800/500/3600
OPTIMIZE FLUX	Optimizing flux will reduce energy consumption for loads operated at less than rated HP. 0 = Flux referenced as nominal 1 = Flux optimization based on motor torque	0/0/1
FLUX REF VALUE	Flux reference value as a percentage of rated flux	100/50/125
SLIP GAIN	Slip gain to adjust motor speed	100/10/400
SPEED PROP GAIN	Proportional (P) gain for speed adjustment	100/10/300
SPEED INT GAIN	Integral (I) gain for speed adjustment	100/20/300
TORQUE PROP GAIN	Proportional (P) gain for torque adjustment	100/10/300
TORQUE INT GAIN	Integral (I) gain for torque adjustment	100/20/300
ATtype, EN=1, ST=0	Reserved	0/0/1
PwrOn AT? YES=1	0 = no auto tuning on initialization (when input power is cycled OFF/ON) 1 = auto tuning each time the drive is initialized (see Note 1)	0/0/1
RATED HORSEPOWER	Motor name plate horse power	APGx20: 20/1/20
		APGx30: 30/1/30
		APG440: 40/1/40
		APG450: 50/1/50
		APG460: 60/1/60
RATED CURRENT	Motor name plate current in amps	APG475: 75/1/75
		APGx20: 30/5/35
		APGx30: 46/5/50
		APG440: 60/10/70
		APG450: 75/10/87
		APG460: 92/10/100
		APG475: 107/10/118
Rs	Stator resistance in Ohms	0.001/0/10.000
Rr	Rotor resistance in Ohms	0.001/0/10.000

Adjustable Parameters

DISPLAY MESSAGE	DESCRIPTION	DEFAULT/MIN /MAX VALUE
Ls	Stator self inductance ($L_s = L_{sl} + L_m$) in mH	0.1/0/1000.0
Lm	Mutual inductance in mH	0.1/0/1000.0
TORQUE LIMIT	Torque limit as a percentage of maximum torque of the motor	100/10/125

Note 1: When power on auto tuning (***PwrOn AT***) is selected, the drive will auto tune motor parameters every time the drive is initialized. The auto tuning will be either standard (motor shaft does not turn) or enhanced (motor shaft will turn—loads must be disconnected from shaft) depending on how the parameter ***ATtype*** is set.

Adjustable Parameters

Table 5-5 Interface Parameters

DISPLAY MESSAGE	DESCRIPTION	DEFAULT/MIN /MAX VALUE
CONTRAST LEVEL	Sets contrast level of backlit LCD display	50/1/100
INPUT MODE	<p>Selects the type of transducer connected to the analog input terminals.</p> <ul style="list-style-type: none"> • 0 = 0-5VDC • 1 = 4-20mA. 	1/0/1
SYSTEM CONFIG	<p>Sets the system configuration.</p> <ul style="list-style-type: none"> • 0 = On/off control using AUX1 and AUX2. Both AUX1 and AUX2 must have a contact closure to run. • 1 = Motor speed control proportional the analog signal on Terminals J10-4 & J10-5 (0-5 VDC) or J10-7 & J10-8 (4-20mA). Both AUX1 and AUX2 must have a contact closure to run. • 2 = Analog constant pressure system. • 3 = Digital constant pressure system. • 4 = On/off control using AUX1 and AUX2. Both AUX1 and AUX2 must have a contact closure to run. AUX3 controls Forward/Reverse function. Open = Forward, Closed = Reverse • 5 = Motor speed control proportional the analog signal on Terminals J10-4 & J10-5 (0-5 VDC) or J10-7 & J10-8 (4-20mA). Both AUX1 and AUX2 must have a contact closure to run. AUX3 controls Forward/Reverse function. Open = Forward, Closed = Reverse • 6 = AC to DC converter mode. Load side module is turned off. DC power can be fed directly to the DC bus. AUX1 and AUX2 must have a contact closure to run. • 7 = DC to AC inverter mode. Line side module is turned off. DC power can be fed directly to the DC bus. AUX1 and AUX2 must have a contact closure to run. • 8 = Analog constant pressure (4-20 mA only) or motor speed control by potentiometer. When AUX4 is open the drive is in OFF mode. If AUX4 is closed, AUX3 selects either constant pressure control, or motor speed control by a potentiometer on the 0-5VDC input. When AUX3 is closed the frequency is controlled by the potentiometer. When the speed is controlled by the potentiometer, the emergency over-pressure control on AUX2 is enabled. 	0/0/10

Adjustable Parameters

DISPLAY MESSAGE	DESCRIPTION	DEFAULT/MIN /MAX VALUE
	<ul style="list-style-type: none"> • 9 = Digital constant pressure or motor speed control by potentiometer. See System Configuration 8 for function of AUX3 and AUX4. • 10 = Motor speed control proportional the analog signal on Terminals J10-4 & J10-5 (0-5 VDC) or J10-7 & J10-8 (4-20mA). Both AUX1 and AUX2 must have a contact closure to run. When contacts on AUX3 open during drive operation, the input will remain in that state until manual reset by simultaneously pushing the up-arrow and down-arrow keys or by cycling input power OFF/ON. 	
DIGITAL INPUT MODE	Reserved	0/0/0
ANALOG 1 SELECT	Programmable 0-5VDC analog output on Terminal J10-3 0 = Output Hz $0.8 * \text{motor Hz} / \text{maximum Hz} * 5V$ 1 = Output Torque $(0.5 - 0.5 * \text{torque} / \text{rated torque}) * 5V$ 2 = Output Voltage $(\text{output voltage} / 1000V) * 5V$ 3 = DC Bus Voltage $(\text{bus voltage} / 1000V) * 5V$ 4 = Out KW $(0.6 * \text{output KW} / (\text{rated HP} * 746)) * 5V$ 5 = 0-5V Input $(\text{input} / \text{full scale input}) * 5V$ 6 = 4-20mA Input $(\text{input} / \text{full scale input}) * 5V$ 7 = Output Current Ia $(\text{current} / \text{max rated current}) * 5V$ 8 = Output Current Ib $(\text{current} / \text{max rated current}) * 5V$ 9 = Output Current Ic $(\text{current} / \text{max rated current}) * 5V$	0/0/9
ANALOG 2 SELECT	Programmable 0-5VDC analog output on Terminal J10-2 0-9 same as COM1 SELECT above	1/0/9
RLY 1/2/3 OUTPUT	Programmable normally open / normally closed relay. Terminals J8-1, J8-2, J8-3. Factory default value is 0, System Fault 0 = System Fault Closed = normal, Open = fault 1 = Duplex Slave Control	0/0/4

Adjustable Parameters

DISPLAY MESSAGE	DESCRIPTION	DEFAULT/MIN /MAX VALUE
	Closed = slave on, Open = slave off 2 = Speed Limit RPM (wind turbine mode) Closed = Drive is in control of turbine Open = Drive is in state other than RUN 3 = Shutdown RPM (wind turbine mode) Closed = Drive is in control of the turbine Open = Drive has stopped turbine due to low RPM 4 = Pump Fault e.g. motor overload, dry well, etc. Closed = normal operation, Open = fault 5 = Minimum Frequency. Relay changes state when motor frequency is greater than the value set by parameter MINIMUM FREQ.	
RLY 4/5 OUTPUT	Programmable normally open relay. Terminals J8-4, J8-5. Factory default value is 4, Pump Fault. See Parameter RLY 1/2/3 OUTPUT above for description of values.	4/0/4
RLY 6/7 OUTPUT	Programmable normally open relay. Terminals J8-6, J8-7. Factory default value is 1, Duplex Slave Control See Parameter RLY 1/2/3 OUTPUT above for description of values.	1/0/4
ANALOG IN REVERS	Reverses the scale of the analog signal. For example, in normal 0-5VDC signal, 0V = low and 5V = high. In reverse, 5V = low and 0V = high. 0 = normal, 1 = reverse	0/0/1
MODBUS ID	Address of the drive for a modbus network	1/0/1000
MODBUS DATA RATE	Modbus serial data rate	19200/4800/19200
MODBUS PARITY	Determines how the parity bit of the character's data frame is set.	None/Odd/Even
MODBUS STOP BITS	Number of bits transmitted after each character to detect the end of the character	1/1/2
MB TRANSMIT DLAY	Time delay in milliseconds between query and response	3/3/30

Adjustable Parameters

Table 5-6 Wind Turbine Parameters*

DISPLAY MESSAGE	DESCRIPTION	DEFAULT/MIN /MAX VALUE
SPEED LIMIT (RPM)	The upper limit allowed for generator RPM. When this limit is exceeded the drive will begin a shutdown ramp to STOP. Ramp time will be set by the parameter SHUTDOWN RAMP (see Table 5-1). For notification when STOP is achieved, set parameter RLY 4/5 OUTPUT NO to 2. This normally open relay between Control Terminals J8-4 and J8-5 will be closed when the drive is in control of the turbine and open when it is in any state other than RUN.	1800/0/3600
Tdelay LOW RPM	Time in seconds the drive is allowed to motor the turbine at low RPM before starting shutdown ramp.	10/5/100
BAND 1 (LOW RPM)	Lower limit of a speed band in which the turbine will not operate.	0/0/3600
BAND 1 (HIGH RPM)	Upper limit of a speed band in which the turbine will not operate.	0/0/3600
BAND 2 (LOW RPM)	Lower limit of a speed band in which the turbine will not operate.	0/0/3600
BAND 2 (HIGH RPM)	Upper limit of a speed band in which the turbine will not operate.	0/0/3600
BAND 3 (LOW RPM)	Lower limit of a speed band in which the turbine will not operate.	0/0/3600
BAND 3 (HIGH RPM)	Upper limit of a speed band in which the turbine will not operate.	0/0/3600
DELAY SPEED LIM	Time in seconds the drive allows the turbine to exceed the speed limit set by parameter SPEED LIMIT (RPM) . CAUTION! During this interval the drive will allow the turbine speed to increase without limit.	0/0/10
SHUTDOWN RPM	Lower RPM limit of the generator. The drive will continue to motor the generator at minimum speed for the time set by parameter Tdelay, LOW RPM , then will ramp to stop if generator is not producing power before Tdelay, LOW RPM time expires. For notification when STOP is achieved, set parameter RLY 4/5 OUTPUT NO to 2. This normally open relay between Control Terminals J8-4 and J8-5 will be closed when the drive is in control of the turbine and open when it is in any state other than RUN.	0/0/3600
GEN ?: PM=1, Ind=0	Reserved	0/0/1

Adjustable Parameters

DISPLAY MESSAGE	DESCRIPTION	DEFAULT/MIN /MAX VALUE
MaxPwr Search	Setting = 0: Turbine will operate at MAX FREQUENCY so long as power is produced at that speed. To avoid motoring the turbine, speed will be decreased if power is not produced, ultimately reaching SHUTDOWN RPM. Setting = 1: Drive will search for peak power by varying speed in the desired direction.	0/0/1
OPTIMIZE PWR 1	In kW, point 1 on the turbine power curve for determining power optimization algorithm.	0.0/0.0/60.0
OPTIMIZE SPEED 1	In RPM, point 1 on the turbine power curve for determining power optimization algorithm.	0/0/3600
OPTIMIZE PWR 2	In kW, point 2 on the turbine power curve for determining power optimization algorithm.	0.0/0.0/60.0
OPTIMIZE SPEED 2	In RPM, point 2 on the turbine power curve for determining power optimization algorithm.	0/0/3600
OPTIMIZE PWR 3	In kW, point 3 on the turbine power curve for determining power optimization algorithm.	0.0/0.0/60.0
OPTIMIZE SPEED 3	In RPM, point 3 on the turbine power curve for determining power optimization algorithm.	0/0/3600
OPTIMIZE PWR 4	In kW, point 4 on the turbine power curve for determining power optimization algorithm.	0.0/0.0/60.0
OPTIMIZE SPEED 4	In RPM, point 4 on the turbine power curve for determining power optimization algorithm.	0/0/3600
OPTIMIZE PWR 5	In kW, point 5 on the turbine power curve for determining power optimization algorithm.	0.0/0.0/60.0
OPTIMIZE SPEED 5	In RPM, point 5 on the turbine power curve for determining power optimization algorithm.	0/0/3600

*Wind turbine control parameters are activated by setting DIP switch 4 on the Master Control (MC) printed circuit board to the ON position. This will deactivate Constant Pressure control parameters and they will not be visible in the keypad menu.

6.1 Commissioning the Unit

It is always advisable to check the operating status of the converter and its load before commencing regular operation.

Ground Fault Detection

APG Series drives are equipped with a feature to detect a fault between any of the output lines and earth. See Table 5-1, *Operating Parameters*, **GND FAULT DETECT**, for more information on using this parameter. If a ground fault is strong enough to trigger the parameter **GND FAULT DETECT**, the drive will not allow the IGBTs to switch. However, this does not protect the drive from damage in all situations. The fault may cause the DC bus voltage to rise beyond normal levels and damage the bus capacitors even when the IGBTs are off. **If a ground fault occurs, immediately disconnect the input power!**

 **CAUTION:** Before the motor is connected to the output terminals, check all output lines for line-to-ground faults using a megger. There is a direct path through the drive circuitry for ground fault currents that can be triggered when power is applied to the input terminals, even though the output switches are not activated. These currents can cause serious damage to drive circuitry and are not covered under warranty.

Initial Operation

Verify the following:

1. The unit is securely attached to the proper mounting surface
2. The unit's input terminals are connected to an appropriate power source
3. An appropriately rated motor is connected to the output terminals
4. The motor is secured and properly mounted

 **WARNING!** The default operating mode when the unit is energized is OFF. If the parameter ENABLE RESTARTS has been set to allow restarts, the unit will energize in AUTO mode. If the external controls are calling for a motor run condition, the motor will start. Make sure either external controls are off before energizing the input, or push the OFF key as soon as the unit has initialized. Refer to Section 4.1, *Using the Keypad and Display*, for instructions on operating the keypad.

1. If remote or automatic ON/OFF function is required, connect remote switch leads to the AUX1 terminals. An additional remote switch or jumper wire may be connected to the AUX2 terminals.
2. If a Constant Pressure (CP) water system will be operated, connect the pressure sensors to the appropriate Control Terminals. See Section 7, *Constant Pressure Systems* for details.

3. Apply power to the input terminals of the drive by turning on the input circuit breaker or disconnect switch.
4. The LCD text display will scroll through several start-up sequence messages.
5. If the **ENABLE RESTARTS** parameter is set to allow restarts, the drive will initialize in AUTO mode and the motor will run if control signals call for a motor run condition. In order to prevent the motor from running at start-up, immediately after initialization, press the OFF key.
6. Confirm that the unit has properly energized, and the display indicates the OFF mode.
7. Using the keypad and display, navigate to the Main Menu item, **CHANGE PARAMETER VAULES**, to set the following parameters for basic operation (see Tables 5-1, 5-2, 5-3, 5-4, 5-5, 5-6 for details):
 - **INTERFACE PARAMETERS > SYSTEM CONFIG** This parameter is critical to the operation of the system. The default setting is for simple ON/OFF operation. See Section 6.3 *System Configuration*, for complete information.
 - **TORQUE CONTROL PARAMETERS > RATED HORSEPOWER** Enter the nameplate HP of the motor load. This parameter is critical to proper operation of CP water systems and for torque control mode.
 - **OPERATING PARAMETERS > OVERCURRENT LIMIT** This parameter sets the motor overload protection. See Section 6.2 *Motor Overload Protection* for complete information.
 - **OPERATING PARAMETERS > ENABLE RESTARTS** This parameter enables the drive to initialize in AUTO mode and to restart automatically after a fault. Factory default does not allow auto restarts.
8. Push MAN on the keypad for manual mode, then push RUN to start the motor. In manual mode, the RUN key will override an open AUX terminal or other external control signal. Push the STOP key to stop the motor in manual mode.

 **CAUTION:** In manual mode, pushing the RUN key will override all external control signals, including constant pressure sensors. Dangerous pressure rise in closed plumbing systems is possible.

9. The motor will start with the default acceleration ramp time of 0-30 Hz in one second, then 30-60 Hz in eight seconds.
10. Confirm that the motor rotation is correct. Swapping any two of the output leads will reverse the motor rotation.
11. After initial power-up, use the keypad and display to navigate to **CHANGE PARAMETER VALUES** to set any other adjustable parameters you wish to be different from the factory defaults.

6.2 Motor Overload Protection

APG Series converters are equipped with adjustable solid state motor overload protection. Protection is based on a Class 10 trip curve. Motor overload settings are selected by navigating to the appropriate menu item using the keypad and display.

Setting Motor Overload Protection with Keypad

To set motor overload protection with the keypad, navigate to the Main Menu item **CHANGE PARAMETER VALUES > CHANGE OPERATING PARAMETERS > OVERCURRENT LIMT**. Refer to Section 5.1 *Changing Parameter Values*, Table 5-1 *Operating Parameters* for detailed instructions.

6.3 System Configuration

An APG Series drive is capable of operating several types of systems, including constant pressure water systems, variable speed systems based on analog inputs, and simple ON/OFF control from remote switches. **The correct system configuration must be selected for proper operation of the different types of control systems!**

System configuration is set by navigating to the keypad Main Menu item **CHANGE PARAMETER VALUES > CHANGE INTERFACE PARAMETERS > SYSTEM CONFIG**. Refer to Section 5.1 *Changing Parameter Values*, Table 5-5, *Interface Parameters*, for detailed instructions. Below is a brief description of each configuration setting:

- **System Configuration 0:** This is the factory default configuration for basic operation of the drive and allows ON/OFF control of the motor using a dry contact on AUX1 and/or AUX2. Both AUX1 and AUX2 must have a contact closure to run.
- **System Configuration 1:** This setting allows motor speed control proportional the analog signal on Terminals J10-4 & J10-5 (0-5 VDC) or J10-7 & J10-8 (4-20mA). Both AUX1 and AUX2 must have a contact closure to run. This setting should NOT be used for analog constant pressure control.
- **System Configuration 2:** Use this setting when operating analog constant pressure systems. The pressure transducer must 4-20 mA. Refer to Section 7.4, Analog Constant Pressure Systems, for more information on operating the drive in this mode.
- **System Configuration 3:** Use this setting when operating digital constant pressure systems. Only use digital pressure switches purchased from or approved by Phase Technologies. Refer to Section 7.3, Digital Constant Pressure Systems, for more information on operating the drive in this mode.

- **System Configuration 4:** In this configuration the AUX3 Control Terminal allows the motor to run in reverse. AUX3 Open = Forward, AUX3 Closed = Reverse. Motor ON/OFF control is accomplished as in System Configuration 0. Both AUX1 and AUX2 must be closed to run.
- **System Configuration 5:** In this configuration motor speed control is proportional the analog signal on Control Terminals J10-4 & J10-5 (0-5 VDC) or J10-7 & J10-8 (4-20mA). Both AUX1 and AUX2 Control Terminals must have be closed to run. AUX3 controls Forward/Reverse function. Open = Forward, Closed = Reverse
- **System Configuration 6:** AC to DC converter mode. The load side module is turned off. DC power can be fed directly to the DC bus. AUX1 and AUX2 must have a contact closure to run.
- **System Configuration 7:** DC to AC inverter mode. Line side module is turned off. DC power can be fed directly to the DC bus. AUX1 and AUX2 must have a contact closure to run.
- **System Configuration 8:** Analog constant pressure (4-20 mA only) or motor speed control by potentiometer. When AUX4 is open the drive is in OFF mode. If AUX4 is closed, AUX3 selects either constant pressure control, or motor speed control by a potentiometer on the 0-5VDC input. When AUX3 is closed the frequency is controlled by the potentiometer. When the speed is controlled by the potentiometer, the emergency over-pressure control on AUX2 is enabled.
- **System Configuration 9** = Digital constant pressure or motor speed control by potentiometer. See System Configuration 8 for function of AUX3 and AUX4.
- **System Configuration 10** = Motor speed control proportional the analog signal on Terminals J10-4 & J10-5 (0-5 VDC) or J10-7 & J10-8 (4-20mA). Both AUX1 and AUX2 must have a contact closure to run. AUX3 is a latching relay. When contacts on AUX3 open during drive operation, the input will remain in that state until manual reset by simultaneously pushing the up-arrow and down-arrow keys or by cycling input power OFF/ON.

 **CAUTION:** Before operating in System Configuration 6 or 7, contact the factory to determine if external DC source is compatible with the drive.

6.4 Start-Up and Shut-Down Ramp Times

Start-up and shut-down ramp times specify the time required to go from Minimum Frequency to Maximum Frequency or vice versa. Ramp times and profiles are adjustable by changing Operating Parameters through the keypad and text display.

Minimum Frequency

Most submersible pump motor manufacturers require the motor to reach 30 Hz within one second in order to protect the pump from damage. Because the APG Series is frequently used for pumping applications, it has a minimum frequency feature that limits the time the

motor runs below the minimum frequency to one second. For example, when the minimum frequency is set to 30 Hz, the motor speed will ramp to 30 Hz in one second, then ramp to the maximum frequency in the default setting in a total of 8 seconds, or in a time set through the adjustable parameter, **START UP RAMP**. This is depicted in Figure 6-1. **The factory default setting for minimum frequency is 30 Hz.**

When the minimum frequency is set to 5, the motor will ramp from stop to the maximum frequency in 8 seconds in a linear fashion as depicted in Figure 6-2.

Setting the Minimum Frequency with Keypad

To set the minimum frequency, navigate to the keypad Main Menu item, **CHANGE PARAMETER VALUES > CHANGE OPERATING PARAMETERS > MINIMUM FREQ > 30 Hz**. When this parameter is set to 5 Hz, ramp times will be linear, as depicted in Figure 6-2.

Figure 6-1 Default Start-Up and Shut-Down Ramp Time

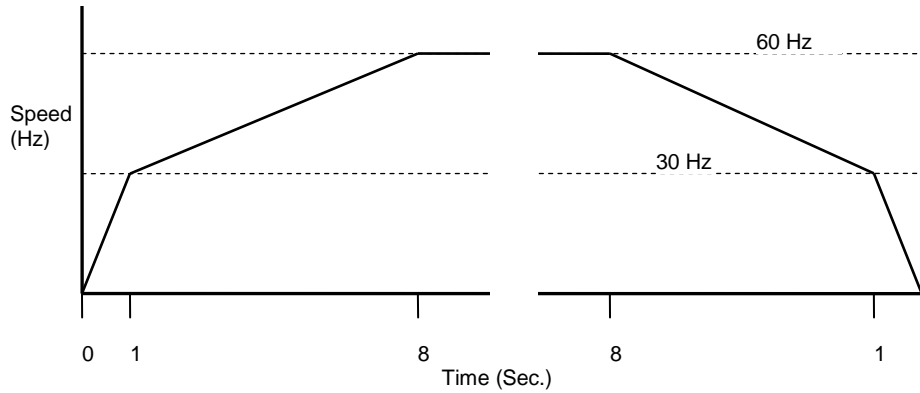
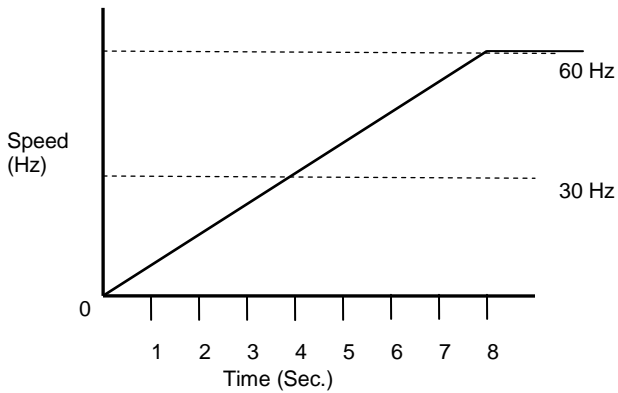

Figure 6-2 Start-Up Ramp with Minimum Frequency 0 Hz



6.5 Controlling Motor Speed with Analog Input

APG Series drives are equipped with analog inputs that allow an external signal of 0-5VDC to control motor speed. A 4-20mA transducer can also control motor speed. The terminals for these signals are located on Control Terminal Block J10. Refer to Table 3-4, *Control Terminal Ratings and Descriptions* for more information on terminal location and rating. The system configuration must be set through the parameter, **SYSTEM CONFIG**, for analog input to control motor speed.

Analog Speed Control Set-up Procedures:

1. Connect the analog input to the appropriate Control Terminals, either 0-5 VDC or 4-20 mA.

 **CAUTION:** 4-20mA signal can only be provided by an analog transducer. Do not provide a 4-20mA signal with external power supply. Power for the 4-20 mA transducer is provided by internal circuits in the drive.

2. Navigate through the keypad Main Menu item **CHANGE PARAMETER VALUES > CHANGE INTERFACE PARAMETERS > SYSTEM CONFIG**. Select **1** to set the system configuration for analog speed control
3. Set the keypad to AUTO mode to operate the system

Analog Input and Minimum Frequency

The analog input signal will control motor speed only between the minimum frequency and the maximum frequency. The motor speed will not be allowed to fall below the minimum frequency, regardless of the signal on the analog input. **The minimum frequency must be set to 5 Hz for the analog signal to control speed between stop and maximum frequency.**

When controlled by analog input, the motor speed will be determined by the ratio of the input signal to the maximum value for that signal. For example, if the Maximum Frequency is set at 60 Hz and Minimum Frequency is set at 5 Hz, an analog signal of 2 VDC would result in a speed of 24 Hz. Remember that if Minimum Frequency is at the default 30 Hz, any signal that calls for speed below Minimum Frequency will be ignored, and the speed will remain at 30 Hz until the signal exceeds 2.5 VDC. The formula for calculating speed is illustrated in Figure 6.3 below.

Figure 6.3 0-5 VDC Analog Input Speed Calculation

Where *Hz max* equals the maximum frequency, *VDC in* equals the analog input signal in volts DC (VDC).

$$\text{Speed (Hz)} = \text{max Hz} \quad \times \quad \left(\frac{\text{VDC in}}{5 \text{ VDC}} \right)$$

$$\text{Speed (Hz)} = 60 \text{ Hz} \quad \times \quad \left(\frac{2}{5} \right)$$

$$\text{Speed (Hz)} = 24 \text{ Hz}$$

6.6 Sensorless Vector Torque Control

APG Series drives operate in either V/f control or torque control mode. When operated in torque control mode, they utilize sensorless vector control to control the torque (and thus finally the speed) of three-phase AC electric motors by controlling the current fed to the machine.

The factory default operation mode is V/f control. Torque control mode can be selected by setting parameters in the keypad menu.

Select Torque Control Mode

Refer to Table 5-4 for the list of torque control parameters. To select torque control mode:

1. Navigate on the keypad to **CHANGE PARAMETER VALUES > TORQUE CONTROL PARAMETERS > SV CONTROL**.
2. Set the value of parameter **SV CONTROL** to 1.
3. Set the value of parameter **RATED RPM** to the nameplate RPM of the motor.
4. Set the value of parameter **RATED HORSEPOWER** to the nameplate horsepower of the motor.
5. Set the value of parameter **RATED CURRENT** to the nameplate current of the motor.

For the majority of applications, entering motor nameplate data is adequate for good torque control. If more precise speed and motor control is required it may be necessary to utilize the advanced features of torque control parameters found in Table 5-4.

Auto Tuning

To enhance the performance of torque control it may be necessary to use the auto tuning feature. When auto tuning is executed, the drive sends voltage signals to the motor that allow it to calculate resistance and inductance values of the motor. The auto tuning process takes about 10 seconds to complete.

There are two types of auto tuning, standard or enhanced. In standard auto tuning mode the drive tunes the motor while the shaft is stationary. In enhanced auto tuning mode the drive spins the shaft of the motor while tuning. Enhanced auto tuning generally results in better torque control, **but load must be disconnected from the motor shaft during tuning**. This can be inconvenient, or in some cases not possible. Inaccurate motor data will result if enhanced auto tuning is executed with a load on the motor shaft.

Select Auto Tune Type

The factory default setting is standard auto tuning (motor shaft stationary).

To select enhanced auto tuning:

1. Disconnect the load from the motor shaft
2. Navigate on the keypad to **CHANGE PARAMETER VALUES > TORQUE CONTROL PARAMETERS > ATtype, EN=1, ST=0.**
3. Set the value of parameter **ATtype, EN=1, ST=0** to 1. Press ENTER to save.

Execute Auto Tuning

Auto tuning can be executed in two ways, manually or automatically every time the drive is initialized (input power is cycled OFF/ON). There is typically no need to auto tune a motor more than once. The drive will retain the motor characteristics in its memory even when the power to the drive is disconnected. Power-on auto tuning can be employed to ensure that a new motor connected to the drive is auto tuned automatically in the event the operator should forget to manually execute auto tuning. The factory default setting is manual execution of auto tuning.

To select power-on auto tuning every time the drive is initialized:

1. Navigate on the keypad to **CHANGE PARAMETER VALUES > TORQUE CONTROL PARAMETERS > PwrOn AT? YES=1.**
2. Set the value of parameter **PwrOn AT? YES=1** to 1. Press ENTER to save.

 **CAUTION:** A combination of power-on auto tuning and enhanced auto tuning requires that the load be disconnected from the motor shaft every time the input power to the drive is turned on. This is not practical in most applications. If the motor is auto tuned in the enhanced mode with a load on the shaft, inaccurate motor parameters will be measured, resulting in poor torque control.

Auto tuning can be executed manually from the Main Menu on the keypad.

To manually execute auto tuning:

1. Navigate on the keypad to Main Menu item **ENTER AUTO TUNING MODE.** Press ENTER.
2. The display message will read: **START AUTO TUNE? PRESS ENTER.** Press Enter to execute auto tune.
3. When the auto tune process is complete the display will read: **STATUS: DONE PRESS MENU TO EXIT.** Press MENU to exit and return to the Main Menu.

APG drives can be configured as constant pressure (CP) water systems using either an analog pressure transducer (which we will refer to as an analog constant pressure system) or pressure switches (which we will refer to as a digital constant pressure system). A CP water system includes a pressure tank, a pressure gauge to observe system pressure, and pressure switches or sensors

7.1 Control Principles of Constant Pressure Systems

In a CP system, a target pressure for the system is set either on the switch itself (digital CP) or through the keypad (analog CP). Signals from the sensors interact with firmware in the drive controller to control the motor speed and maintain a constant water pressure.

In a strict definition of a constant pressure system, the pump would never turn off. If the pressure differential between pump-on and pump-off was actually zero, the noise fluctuations of the transducer output would cause the motor to cycle constantly between the on and off states. For this reason, most applications will want to accept a small differential pressure in the system in order to prevent either continuous running of the motor, or constant on/off cycling of the motor.

Preventing Short Cycling During Low Flow Conditions

When a CP system is in a low flow state, it is desirable to turn the motor off in order to conserve energy and preserve the motor. The adjustable parameters **TOFF**, **T1ON**, **T2ON**, **SHUTOFF PMIN** and **BOOST AMOUNT** control when the motor is turned off, how long it is off and also prevent short cycling of the motor at low water flow rates. More information including default values for these parameters can be found in Table 5-4 *Constant Pressure Parameters*.

When water flow in the system is low, the pump motor will consume less power than what is required to pump larger flows. When the HP output of the drive falls below the value of **SHUTOFF PMIN**, the constant pressure control algorithm gives the system a slight boost in pressure before shutting off the motor. The amount of boost is determined by the parameter, **BOOST AMOUNT**.

This low power threshold parameter, **SHUTOFF PMIN**, is defined as a per cent of the rated motor HP. It is important to enter the rated HP of the motor load in the adjustable parameter, **RATED HP**, so that the system calculates an accurate **SHUTOFF PMIN**. The default value for **SHUTOFF PMIN** is 25% of the rated motor HP.

The controls also record the length of time the motor remained in the OFF cycle and compare that time to the parameter, **TOFF**. If the motor-off time during the last OFF cycle was greater

Constant Pressure Systems

than the value of **TOFF**, then the minimum motor-on time will be equal to **T1ON**. If the motor-off time was less than **TOFF**, the minimum motor-on time will be equal to **T2ON**.

In other words, the time of the last OFF cycle determines whether the next ON cycle should be relatively long or relatively short. The graphic in Figure 6-1 demonstrates how the system adjusts the motor-on time in response to motor-off time.

As the water flow in the system increases, the HP consumed by the motor will increase, in which case the **T1ON** and **T2ON** settings will be ignored and the motor will remain ON so long as the HP input to the motor remains above the **SHUTOFF PMIN** threshold.

Figure 7-1 Motor-On and Motor-Off Times

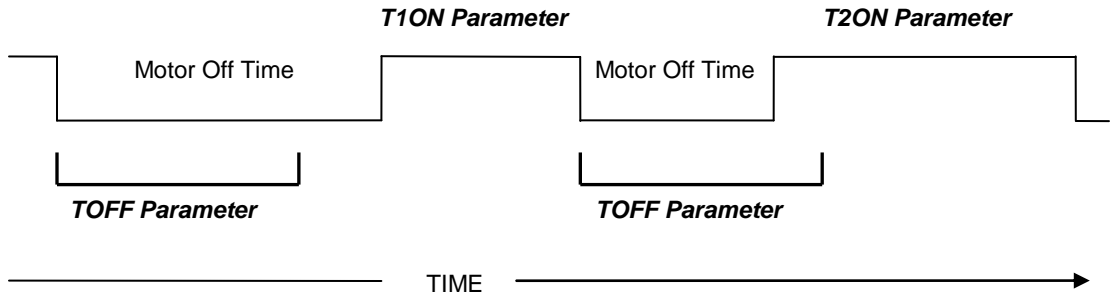

Controller Gain and Ramp Time

The stability of the constant pressure system (i.e., its tendency **not** to exhibit pressure oscillations) is determined by parameters set on the keypad, the flow rate of the pump, and the volume of the pressure tank. Stability of a system with a large maximum flow rate and a small pressure tank will be more difficult to control and may require de-tuning the system to accept larger variations in the system pressure and longer response times. Through the keypad, the user can set parameters for **CONTROLLER GAIN**, **START UP RAMP**, and the **SHUTDOWN RAMP**.

Larger values for **CONTROLLER GAIN** give smaller error in the pressure, but also make the system more susceptible to oscillation. When gain is set to a value less than 1 the keypad displays SIMPLE MODE and the controller switches to an algorithm which does not require a gain setting. This is the factory default setting and will be adequate for most applications.

Constant Pressure Systems

The acceleration and deceleration rates of the motor are controlled by the **STARTUP RAMP** and **SHUTDOWN RAMP** parameters. These parameters affect the response time of the pump to large changes in flow and the tendency of the pump speed to wobble or oscillate at a constant flow rate. Small values of **START UP RAMP** and **SHUTDOWN RAMP** allow the system to correct more rapidly for changes in flow, but also make the system more susceptible to pressure oscillations.

APG drives are shipped with default ramp values of 8 seconds, which will suppress motor speed oscillations. The response time to abrupt changes in flow rate can be reduced by decreasing ramp time. The maximum flow rate of the pump and the size of the pressure tank installed will determine the minimum values that can be used. A system with a high flow rate pump coupled to a small pressure tank will be more difficult to control.

Emergency Over-Pressure Limit Switch

Both digital and analog CP systems require an emergency over-pressure limit switch connected to the AUX2 terminals in case the main pressure control system fails. The emergency over-pressure set-point should be at least 10 PSI higher than the system control pressure to prevent nuisance tripping.

7.2 Troubleshooting Constant Pressure Systems

A variety of conditions in a plumbing system can lead to less than optimum performance of constant pressure control while using the factory default settings. The default settings are designed to operate a range of plumbing systems, but there can be many variables in a plumbing system that require adjustment of the constant pressure parameters.

In order for the drive to stop the pump while operating in constant pressure mode, three conditions must be met:

1. The pressure in the system must be at the pressure control point set by the parameter TRANSDUCER SETPT (for analog systems) or at the pressure determined by the setting on the digital pressure switch
2. The power consumed by the pump must be less than the value of parameter SHUTOFF PMIN
3. The time expired since the pump started after the last OFF cycle must be greater than parameter T1ON or T2ON

When these conditions have been met, the drive will speed up briefly to boost the pressure above the set-point, then ramp down to stop. The amount of boost is set by parameter **BOOST AMOUNT**. Boosting the pressure above the set-point allows some time to pass before flow bleeds the pressure down to the set-point, at which point the pump will restart. When setting and testing a constant pressure system, try to operate as close as possible to

Constant Pressure Systems

the normal operating conditions. Low flow in a high capacity system usually requires some adjusting of the parameters.

SHUTOFF P_{MIN} Too Low

A common problem that prevents the pump from stopping is a value too low for **SHUTOFF P_{MIN}**. The factory default value is 25% of the rated motor HP as determined by the parameter **RATED HP**. By observing the HP reading on the display, one can determine if the HP consumed by the pump at low flow is greater or less than **SHUTOFF P_{MIN}**. One can even consider completely turning off all flow in the system for a short period of time to determine how much power the pump consumes when moving no water. Make sure **SHUTOFF P_{MIN}** is greater than the HP consumed at low flow.

Adjusting Gain in an Analog CP System

When using an analog pressure transducer for control in constant pressure water systems, it is very common for the system controller to use a proportional-integral (PI) controller in the feedback loop. This type of controller has a gain adjustment which must be tuned by the user to obtain optimum performance for each particular application. APG Series drives have this type of controller incorporated in them. However, Phase Technologies has also developed a proprietary controller which does not require tuning. When the **CONTROLLER GAIN** parameter is set at the lowest value, the display will read "**SIMPLE MODE**". This is the default setting of **CONTROLLER GAIN**. In SIMPLE MODE a set of control equations is used which does not require the user to tune the system to obtain acceptable performance. We recommend that you try this first because in most cases it will work fine and is simpler to set up. A well tuned PI controller will give slightly smoother pressure control but it's difficult to see the improvement unless you have a graphics recorder monitoring the output of the pressure transducer. When the controller is in SIMPLE MODE, the only parameters which affect the pressure control loop are the **TRANSDUCER SETPT** and the **BOOST AMOUNT**, which function in the same way as they do in the PI control mode.

In order for the boost phase to work properly when using an analog pressure transducer in PI control mode, it is very important that the **CONTROLLER GAIN** be set for correct tracking of the pressure. The gain has a low default setting so that when the drive is initially started there will be little likelihood of pressure oscillations in the system. However the default setting may not give good pressure tracking. If that is the case, then the actual system pressure will be significantly lower than the **TRANSDUCER SETPT** entered in the keypad.

For example, a system with a pressure transducer that has a range from 0-200 psi and a **TRANSDUCER SETPT** at 25% should give a system pressure of $0.25 \times (200 \text{ psi}) = 50 \text{ psi}$. Assume the **CONTROLLER GAIN** is still at the default value of 5. The drive starts and the system pressure only comes up to 30 psi even with zero or very low water flow. When the pressure is controlled at low flow the pump is likely running at low speed. At low speeds the

Constant Pressure Systems

drive has difficulty interpreting the analog signal from the transducer and this leads to inaccurate pressure control. The speed will not go below **MINIMUM FREQ**, which in the case of a submersible pump must be 30 Hz to protect the thrust bearing of the pump.

During boost, the speed increases resulting in a more accurate boost pressure. In other words, the pressure control point will be inaccurate and low, but the boost control point will be accurate. Turn-on will also occur accurately at the set-point because the drive is not running and there is no low speed condition to confuse the controller. There can be two possible results in this scenario; short cycling or the pump will not stop.

Assume the **BOOST AMOUNT** is also at its default setting of 5%. The boost pressure is then $0.05 \times (200 \text{ psi}) = 10 \text{ psi}$. If the system boosts by 10 psi from 30 psi to 40 psi, that's still below the 50 psi intended set-point, and the controller won't ever turn off. Figure 7-2 illustrates this condition.

There are two possible solutions to this problem. If the **BOOST AMOUNT** is increased to 12%, then the pressure boost would be $0.12 \times (200 \text{ psi}) = 24 \text{ psi}$. The total system pressure during the boost phase would be $30 \text{ psi} + 24 \text{ psi} = 54 \text{ psi}$ which is above the 50 psi set-point, and the pump would stop. The down-side to increasing the boost is the large variation in pressure, in this case 24 psi.

A better solution is an increase the **CONTROLLER GAIN** to get more accurate tracking of the pressure. Increase the gain in small steps and check the behavior of the system to avoid pressure oscillations because of the larger gain value. If the increase in gain were to improve the pressure control from 30 psi to 45 psi, then the default boost amount of 10 psi would be above the 50 psi set-point and the pump would stop. This solution results in only 10 psi pressure variation. Even though the pump has stopped, with only 5 psi between the boost point and the set-point short cycling might occur.

Most situations require a combination of increased gain and boost. In this case, increasing boost to 15 psi would result in a boost point of 60 psi, 10 psi above the set-point, reducing the possibility of short cycling.

Figure 7-2 Adjusting Gain in an Analog CP System

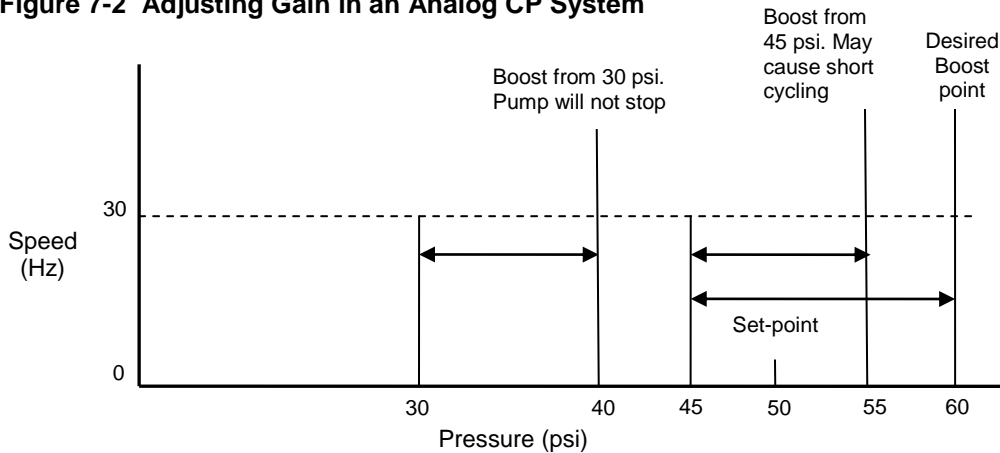

Pressure Control at Minimum Speed

There is a possibility of conflict between the minimum pump speed setting, controlled by the parameter **MINIMUM FREQ**, and the pressure setting of the transducer. That is, if under no-flow conditions the pump at its minimum speed setting produces a pressure greater than the desired set-point, either the minimum speed will have to be reduced (not an option with submersible pumps) or the pressure set-point will have to be increased. Most pumps should not produce enough pressure head at 30Hz for this to be an issue.

Boost in a Digital Constant Pressure System

In a digital CP system the drive can only determine the pressure of the system at the set-point. Based on the characteristics of the on/off signals from the switch, which occur at the set-point, it maintains pressure. The parameter **BOOST AMOUNT** in a digital system is a per cent increase in speed, not in pressure, because the digital switch cannot determine a pressure beyond its set-point.

In an analog system the **BOOST AMOUNT** is a per cent of the full range pressure of the transducer, so the user can accurately control the boost pressure through the parameter setting on the keypad. For example, if the analog transducer has a range of 0-120 PSI, a **BOOST AMOUNT** setting of 10 would be 10% of 120 or 12 PSI.

In a digital system **BOOST AMOUNT** is an increase in speed for a given time as a per cent of the speed the pump was running when the switch last opened at the set-point. For example, if pressure is controlled at a speed of 30 Hz, a **BOOST AMOUNT** value of 10 would be 10% of 30 Hz or 3 Hz. In low flow systems where the pressure is controlled at low speed, the **BOOST AMOUNT** value may need to be significantly higher than it would be set in an analog system under the same conditions.

7.3 Digital Constant Pressure Systems

The digital CP system uses a digital pressure switch connected to the AUX1 terminals (see Figures 7-3 and 7-4 for one-line and wiring diagrams). For digital CP systems, the factory default settings will be satisfactory for most CP applications.

Adjusting Parameters in Digital CP Systems

Using the keypad, there are several parameters which can be adjusted to fine tune digital CP systems. These are **STARTUP RAMP**, **SHUTDOWN RAMP**, **MAX FREQUENCY**, **MINIMUM FREQ**, **TOFF**, **T1ON**, **T2ON**, **SHUTOFF PMIN**, and **BOOST AMOUNT**. The use of these parameters has been discussed in the previous section. Table 5-3 also provides more detail.

Digital Constant Pressure Installation Procedures:

1. Install the digital pressure switches in the water line
2. Remove protective rubber boot from each switch, insert factory provided duplex cable through the boot, and connect a twisted pair of wires to the normally closed (NC) and common (C) terminals of the emergency over-pressure switch

 **CAUTION:** The use of shielded cable is recommended. Regular wire may induce capacitance in the line and corrupt the signals from the pressure switches.

3. Attach the cable shield to the Control Terminal Ground post located in the APG enclosure adjacent to the Control Terminals
4. Connect the emergency over-pressure limit switch to the AUX2 Control Terminals
5. Navigate through the keypad Main Menu item **CHANGE PARAMETER VALUES > INTERFACE PARAMETERS > SYSTEM CONFIG**. Select **3** to set the system configuration for a digital CP system.
6. To set the emergency over-pressure limit switch, remove the rubber boot from the switch and pry the plastic plug from the top of the switch housing to access the pressure adjustment screw. Use an Allen wrench to adjust the pressure setting of the switch – jumper the AUX1 terminals and run the pump in the AUTO mode, and observe the pressure gauge, turning the Allen screw to adjust the pressure shut-off point. **The emergency over-pressure limit switch should be set at least 10 PSI higher than the desired constant pressure set point.**
7. Remove the jumper from AUX1 and connect the remaining twisted pair of wires in the shielded cable to the normally closed (NC) and common (C) terminals of the control pressure switch. Connect the switch to the AUX1 Control Terminals, and adjust the constant pressure set point using the same procedure as the emergency over-pressure limit switch.
8. Set the keypad to AUTO mode to operate the system

Constant Pressure Systems

Figure 7-3 Digital Constant Pressure One-Line Diagram

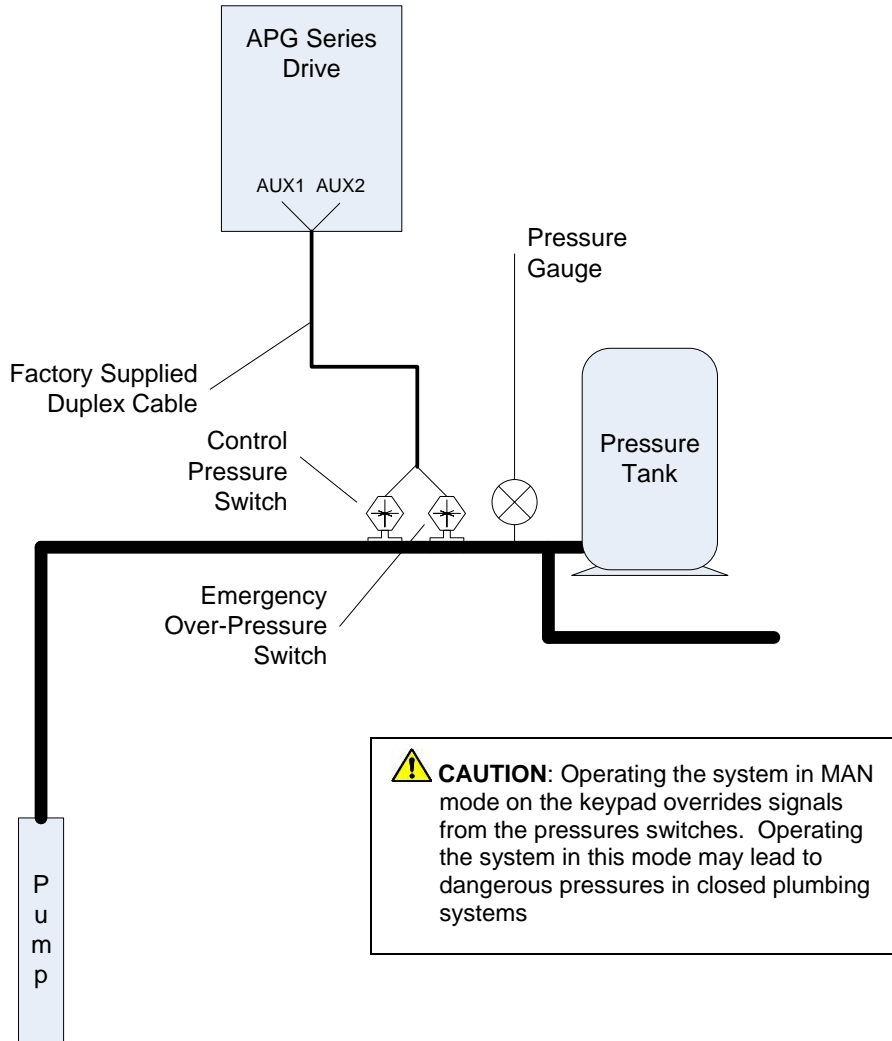

Constant Pressure Systems

Figure 7-4 Digital Constant Pressure System Schematic

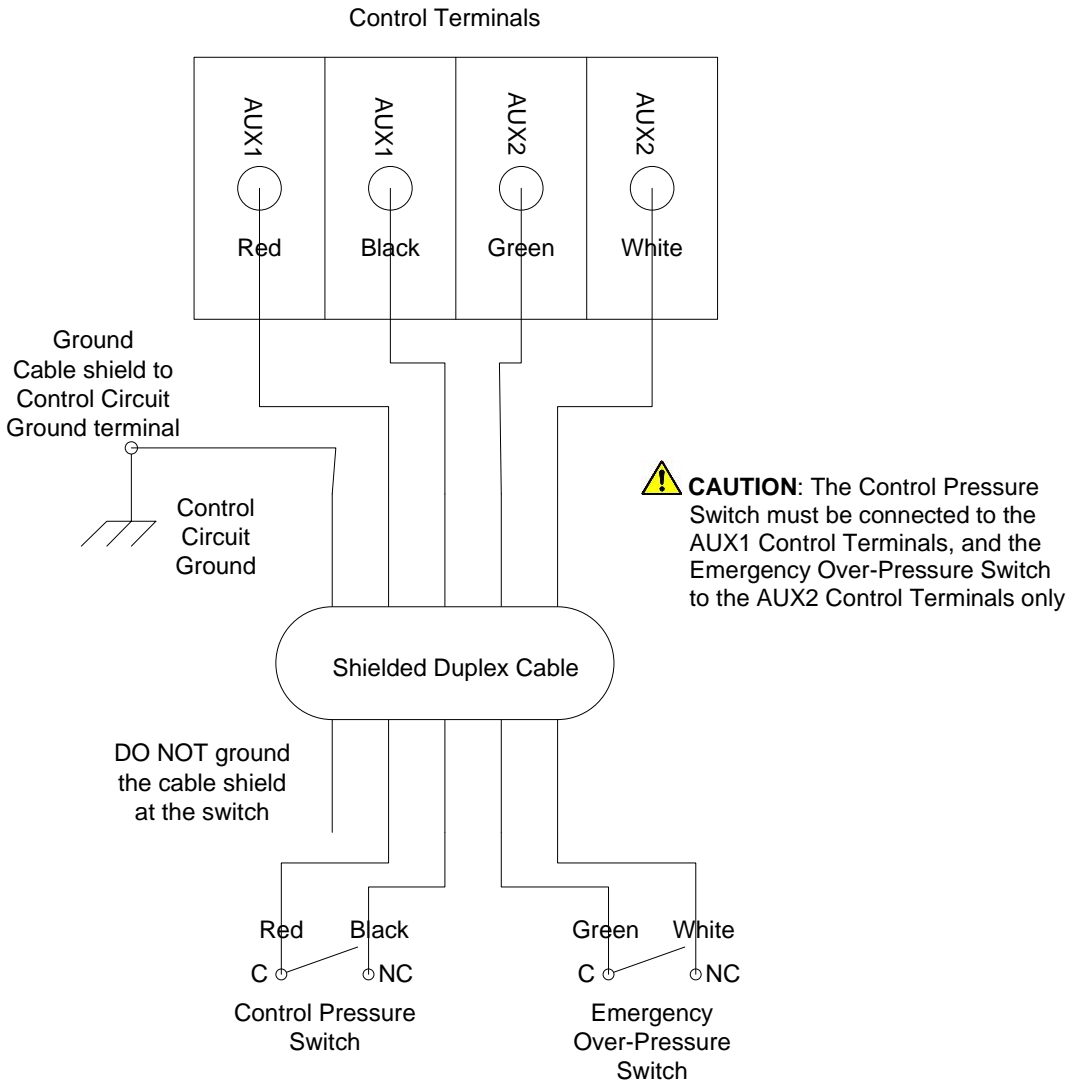

7.4 Analog Constant Pressure Systems

The analog CP system uses an analog pressure transducer connected to the analog input on the Control Terminals (see Figures 7-5 and 7-6 for one-line and wiring diagrams). A normally-closed emergency over-pressure switch connected to the AUX2 terminals is also recommended. These are used in conjunction with the internal firmware of the drive to implement a constant pressure water system.

When using an analog pressure transducer for control in constant pressure water systems, it is very common for the system controller to use a proportional-integral (PI) controller in the feedback loop. This type of controller has a gain adjustment which must be tuned by the user to obtain optimum performance for each particular application. APG Series drives have this type of controller incorporated in them. However, Phase Technologies has also developed a proprietary controller which does not require tuning. When the **CONTROLLER GAIN** parameter is set at the lowest value, the display will read "**SIMPLE MODE**". This is the default setting of **CONTROLLER GAIN**.

In SIMPLE MODE a set of control equations is used which does not require the user to tune the system to obtain acceptable performance. We recommend that you try this first because in most cases it will work fine and is simpler to set up. A well tuned PI controller will give slightly smoother pressure control but it's difficult to see the improvement unless you have a graphics recorder monitoring the output of the pressure transducer. When the controller is in SIMPLE MODE, the only parameters which affect the pressure control loop are the **TRANSDUCER SETPT** and the **BOOST AMOUNT**, which function in the same way as they do in the PI control mode.

In PI control mode the analog signal from the pressure transducer is compared to the parameter **TRANSDUCER SETPT**, which controls the motor speed to maintain constant pressure in the system. In this control scheme, the error signal between the pressure transducer and the internal signal determined by the **TRANSDUCER SETPT** value is multiplied by the **CONTROLLER GAIN**. This signal is then used to determine the motor frequency. If the pressure transducer signal and the internal set-point value were the same, then the motor speed would be zero. High **CONTROLLER GAIN** values give smaller error in the pressure, but also make the system more susceptible to oscillation.

Additional adjustable parameters including **STARTUP RAMP**, **SHUTDOWN RAMP**, **MAX FREQUENCY**, **MINIMUM FREQ**, **TOFF**, **T1ON**, **T2ON**, **SHUTOFF PMIN** **CONTROLLER GAIN**, and **BOOST AMOUNT** help to optimize the performance of the system. The use of these parameters was discussed in the previous section. The unit is shipped with default settings which will work in most applications with no adjustment. As with all systems of this type there are tradeoffs between maintaining a tightly controlled set-point, achieving high motor efficiency and maintaining system stability.

Constant Pressure Systems

Figure 7-5 Analog Constant Pressure One-Line Diagram

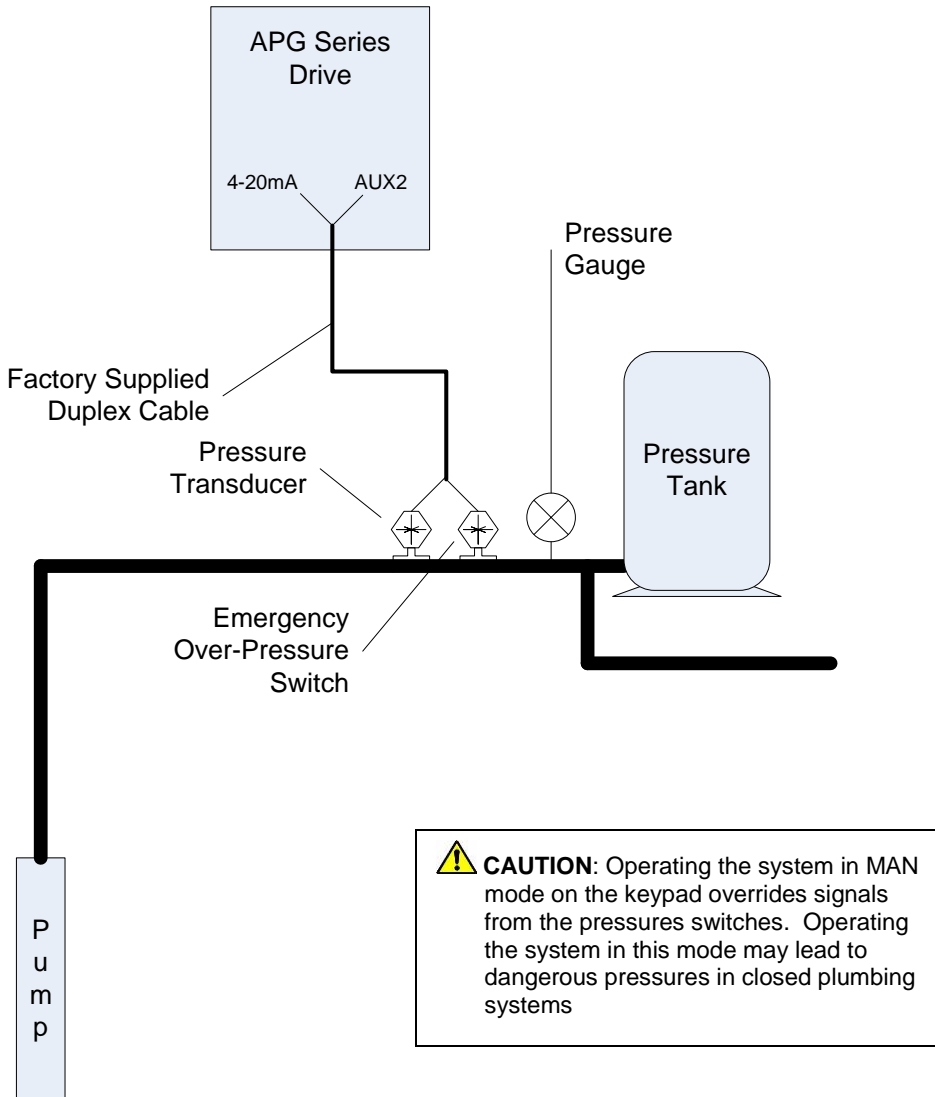

Constant Pressure Systems

Analog Constant Pressure Installation Procedures:

1. Install the analog pressure transducer and emergency over-pressure switch in the water line
2. Remove protective rubber boot from the over-pressure switch, insert factory provided duplex cable through the boot, and connect a twisted pair of wires to the normally closed (NC) and common (C) terminals of the emergency over-pressure switch

 **CAUTION:** The use of shielded cable is recommended. Regular wire may induce capacitance in the line and corrupt the signals from the pressure switches.

3. Attach the cable shield to the Control Terminal Ground post located in the drive enclosure adjacent to the Control Terminals
4. Connect the emergency over-pressure limit switch to the AUX2 Control Terminals
5. Navigate through the keypad Main Menu item **CHANGE PARAMETER VALUES > INTERFACE PARAMETERS > SYSTEM CONFIG**. Select **2** to set the system configuration for an analog CP system (see Table 5-5 for details)
6. Navigate through the keypad Main Menu item **CHANGE PARAMETER VALUES > INTERFACE PARAMETERS > INPUT MODE**. Select **1** for a 4-20 mA analog signal (see Table 5-5 for details)
7. To set the emergency over-pressure limit switch, remove the rubber boot from the switch and pry the plastic plug from the top of the switch housing to access the pressure adjustment screw. Use an Allen wrench to adjust the pressure setting of the switch – jumper the AUX1 terminals and run the pump in the AUTO mode, and observe the pressure gauge, turning the Allen screw to adjust the pressure shut-off point. **The emergency over-pressure limit switch should be set at least 10 PSI higher than the desired constant pressure set point.**
8. Connect the remaining twisted pair of wires to the + and – terminals of the transducer
9. Connect the + terminal of the transducer to the +4-20mA Control Terminal, and the – terminal to the – 4-20mA Control Terminal

 **CAUTION:** It is critical that the + terminal of the transducer is connected to the + terminal of the 4-20mA Control Terminal, and likewise for the – terminals.

10. Set the **TRANSDUCER SETPT** on the keypad (see Table 5-3 *Constant Pressure Parameters* for details)
11. Set the keypad to AUTO mode to operate the system

Constant Pressure Systems

Figure 7-6 Analog Pressure System Schematic

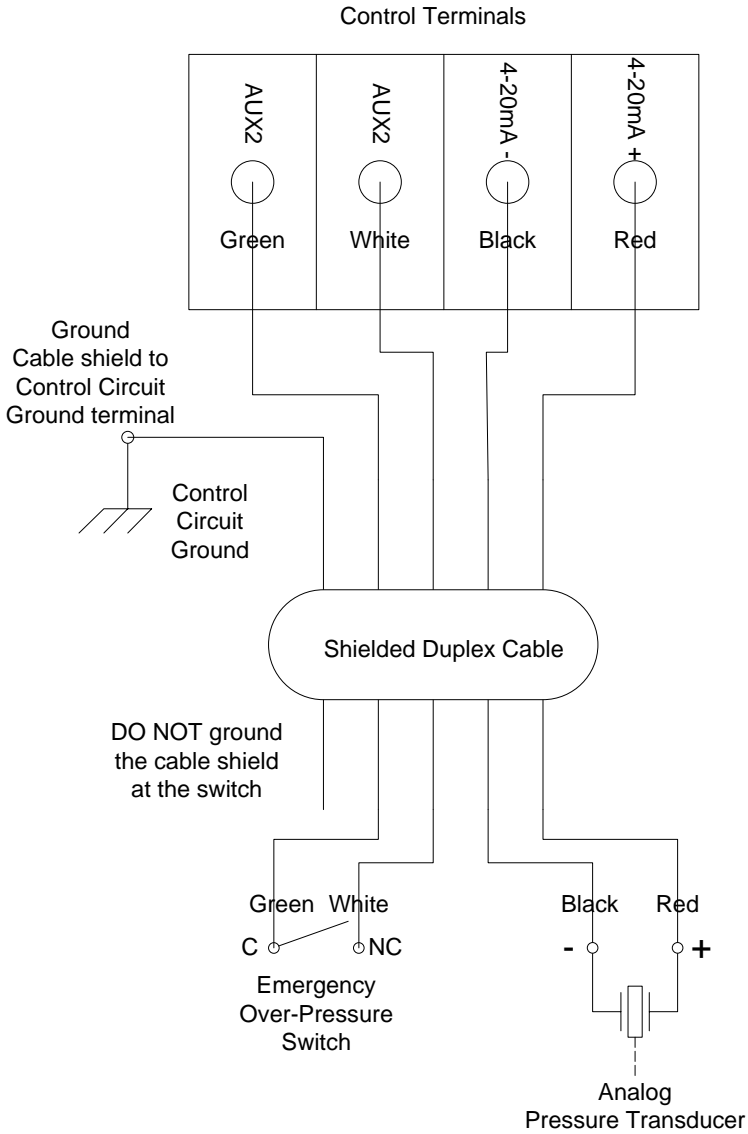

7.5 Pre-Charge Mode

When filling a large plumbing system with water, it may be desirable to fill at a slow pump speed so that when the system reaches the full point, water hammer does not cause damage such as sprinkler head blow-off or burst pipes. To achieve this, APG drives are equipped with a pre-charge feature.

Both the digital and analog constant pressure systems can implement a low-flow pre-charge of the system plumbing before the pump is allowed to come to full speed. This feature is disabled if the **PRECHARGE TIME** parameter is set to zero. For both types of CP systems, the frequency of the pump will not exceed the value set by the **PRECHARGE FREQ** parameter during the pre-charge interval.

In a digital CP system the pre-charge interval is terminated if either the **PRECHARGE TIME** is exceeded or the control pressure is reached.

An analog CP system has the same features with the added option that the pre-charge interval will terminate when the system pressure exceeds the setting of the **PRECHRG SETPOINT** parameter. In this case, the **PRECHRG SETPOINT** must be lower than the **TRANSDUCER SETP**.

In both CP systems the pre-charge interval occurs whenever the drive is switched from OFF to AUTO or MANUAL > RUN.

Pre-charge Mode Setup:

1. Navigate through the keypad menu to **CHANGE PARAMETER VALUES > CONSTANT PRESSURE PARAMETERS > PRECHARGE FREQ**. Enter the Pre-charge frequency.
2. Navigate through the keypad menu to **CHANGE PARAMETER VALUES > CONSTANT PRESSURE PARAMETERS > PRECHARGE TIME**. Enter the Pre-charge time in seconds.
3. For analog CP systems only, navigate through the keypad menu to **CHANGE PARAMETER VALUES > CONSTANT PRESSURE PARAMETERS > PRECHRG SETPOINT**. Enter the pre-charge pressure as a % of the transducer full-scale pressure. This value must be lower than the **TRANSDUCER SETPT**.
4. Set the keypad to AUTO mode to operate the system.

7.6 Duplex Systems

APG Series drives are equipped with a duplex pump feature that allows for integrated control of two drives and two pumps in the same water system. The duplex pump feature will alternate the two pumps on a regular schedule, and can call on the standby pump to bring both pumps online at the same time to maintain pressure in high flow conditions.

In a duplex system, one of the units will operate as a Master and the other will operate as a Slave. **To operate in duplex mode, both Master and Slave must be configured as constant pressure (CP) systems.** Both units also must be configured as the same type of constant pressure (CP) system. See Figures 7-6, 7-7 and 7-8 for one-line and wiring diagrams of a duplex configuration.

The two drives are connected by a shielded cable (available from the factory) from the J8-4 and J8-5 Control Terminals of the Master to the AUX2 terminals of the Slave.

 **CAUTION:** The use of shielded cable is recommended to reduce the noise on the input signals to the drive.

The duplex function is enabled when the **DUPLEX CYC TIME** parameter on the Master unit is set to any value greater than zero. Note: this parameter on the Slave unit must be set to zero. The units can be configured as either analog CP or digital CP systems. **It is essential that the control pressure of the Slave unit be higher (at least 3 PSI) than the control pressure of the Master unit, but lower (at least 5 PSI) than the emergency over-pressure set-point of the Master.** If the Slave control pressure and the Master emergency over-pressure set-points are too close, the system will experience nuisance shut down by the over-pressure switch. The Slave unit requires no special configuration, other than ensuring that its control pressure setting meets these criteria.

The duplex timer on the Master unit is initialized during a power-on reset and begins timing the first cycle. The Master unit will operate as the primary pump during the first cycle. After the **DUPLEX CYC TIME** expires for the first cycle, the Slave unit becomes the primary pump for the same amount of time, and then the Master unit again becomes the primary.

Constant Pressure Systems

If the Master unit is the primary pump and its control pressure device (either switch or transducer) indicates that the Master is not keeping up with the system flow demand, then the Master unit will turn on the Slave unit by closing the relay contacts connected to AUX2 of the Slave. The Slave unit will then remain on until the output power of the Master unit drops below the level determined by the **SHUTOFF PMIN** parameter. At that point the Slave shuts off and the Master is again the only unit running.

When the Slave is the primary pump, the pressure in the system will be slightly higher than the turn-on pressure of the Master unit. If the flow becomes too high for the Slave to maintain the pressure, the Master unit will come on to assist when the pressure has dropped to the turn-on pressure of the Master unit.

Pre-charge in Duplex Mode

The pre-charge function can be enabled in a duplex system, and as in the case of a single drive, pre-charge will happen only once after a power-on reset. Pre-charge is controlled only by the Master unit. The **PRECHARGE TIME** parameter for the Slave unit should remain at zero.

Duplex Mode Setup:

1. Follow the Constant Pressure Installation Procedures in the Section 7.3 or 7.4 to configure the Master and Slave unit as either a digital or analog CP system
2. Install a digital pressure control switch or analog transducer in the water system near the Slave unit
3. Using factory supplied single shielded cable, connect the J8-4 and J8-5 Control Terminals of the Master Unit to the AUX2 Control Terminals of the Slave unit
4. If the slave is configured as a digital CP system, connect a pressure switch to the AUX1 Control Terminals, then set the control pressure in the manner described in Section 7.3, *Digital Constant Pressure Systems*
5. If the Slave is configured as an analog CP system, navigate through the keypad to **CHANGE PARAMETER VALUES > CONSTANT PRESSURE PARAMETERS > TRANSDUCER SETPT** to set the control pressure. The AUX1 terminals must be jumpered for the unit to run.
6. **The Slave control pressure must be at least 3 lb. higher than the Master control pressure set-point, but no less than 5 lb. lower than the emergency over-pressure setting on the Master unit.** If the Slave control pressure and the Master emergency over-pressure set-points are too close, the system will experience nuisance shut down by the over-pressure switch.
7. When the Slave control pressure is set, turn the unit OFF while configuring the Master unit

Constant Pressure Systems

8. Adjust the emergency over-pressure set-point, then the control pressure set-point on the Master, following the Constant Pressure Installation Procedures in the previous section. **The Master control pressure must be at least 3 PSI lower, and the emergency over-pressure setting no less than 5 lb. higher, than the Slave control pressure set-point.**
9. Navigate through the Master unit keypad menu to **CHANGE PARAMETER VALUES > CONSTANT PRESSURE PARAMETERS > DUPLEX PRES DROP**. Enter pressure drop (as a % of the full-scale transducer range) that must occur before the Slave is turned on to assist the Master. See Table 5-4, *Constant Pressure Parameters*, for details.
10. Navigate through the Master unit keypad menu to **CHANGE PARAMETER VALUES > CONSTANT PRESSURE PARAMETERS > DUPLEX CYC TIME**. Enter the cycle time in minutes. Cycle time on the Slave unit must remain at a setting of zero.
11. Set the Master unit keypad to AUTO mode to operate the system
12. Energize the Slave unit, and if it is equipped with a keypad, set in AUTO mode to operate the system.

Constant Pressure Systems

Figure 7-7 Duplex Configuration One-Line Diagram

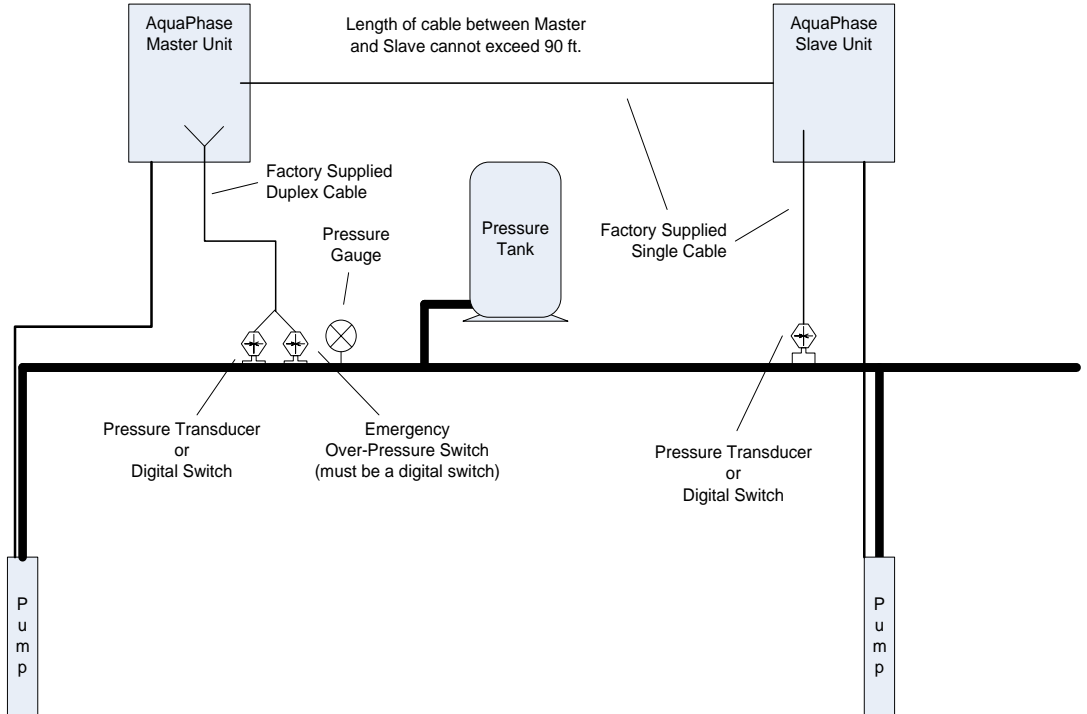

Constant Pressure Systems

**Figure 7-8 Duplex Digital CP Configuration Schematic
(both units configured as digital CP systems)**

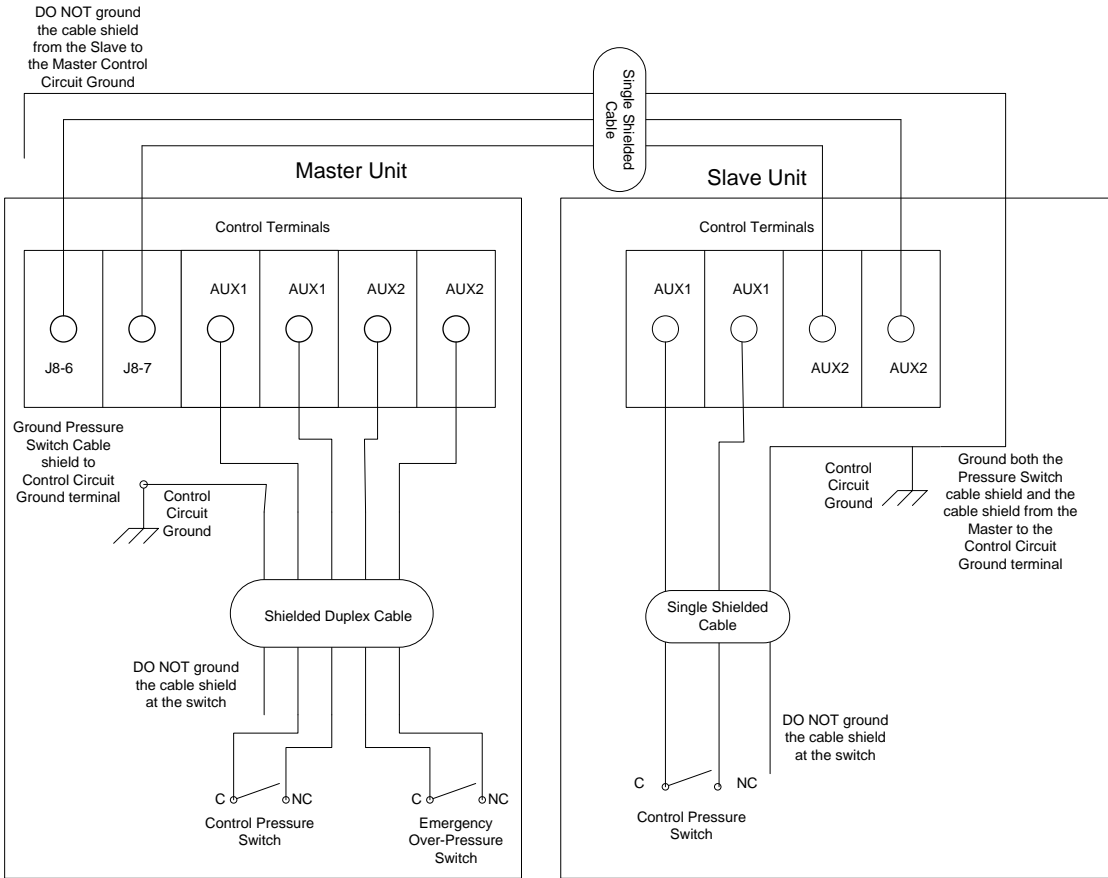
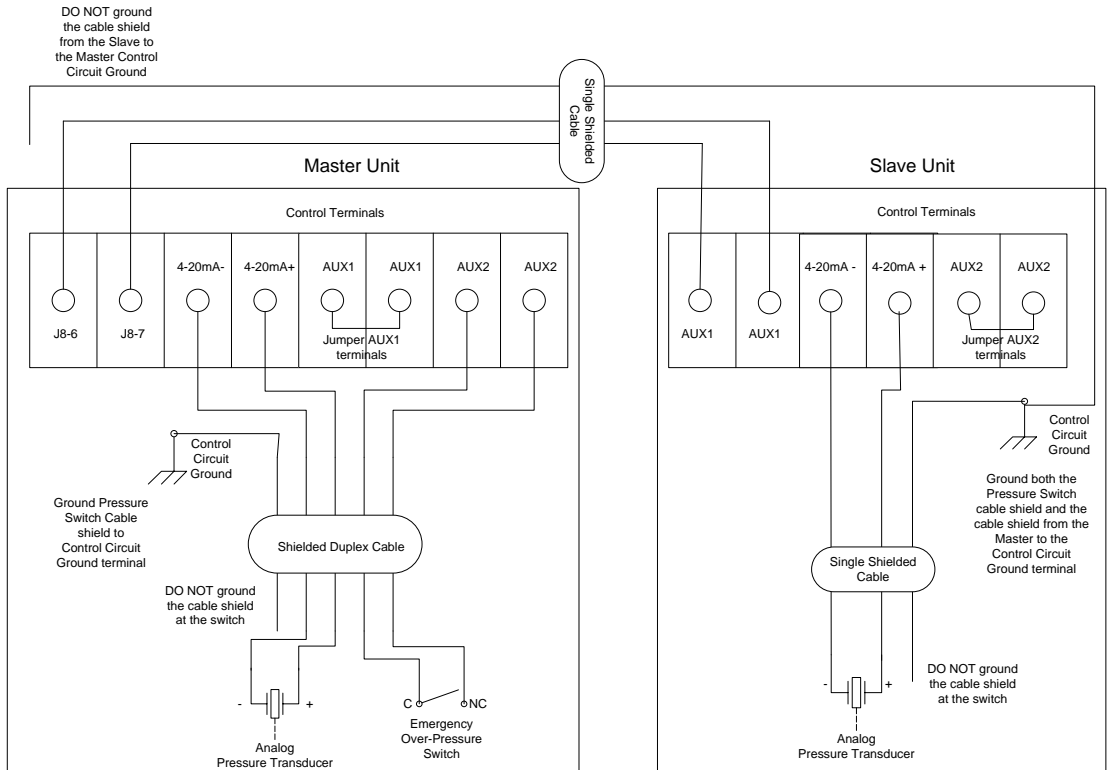

Figure 7-9 Duplex Analog CP Configuration Schematic (both units configured as analog CP systems)



APG Series drives are designed for integration into wind generation systems where it is desired to connect a three-phase turbine to a single-phase grid.

⚠ WARNING! An APG Series drive is not rated and certified to provide anti-islanding protection required on distributed generation installations. Make certain that an appropriately rated anti-islanding relay is included in any installation.

⚠ WARNING! When operating in wind turbine mode, the drive is configured to start the turbine only when it is rotating. A RUN command should be given only when the turbine generator is rotating. Do not start the turbine from a standstill.

8.1 Activation of Wind Turbine Parameters

The drive is equipped with parameters consisting of control algorithms created especially for the control and optimization of wind turbines. These parameters are not activated in the standard factory configuration. Activation of wind turbine parameters is accomplished by setting DIP switch 4 on the Master Control printed circuit board to the ON position. Remove the front cover from the drive in order to access the DIP switch array as depicted in Figure 8-1.

Figure 8-1 DIP Switch Array

DIP switch array. Set switch 4 to ON to activate wind turbine parameters.

⚠ WARNING: Risk of electric shock. De-energize the unit by disconnecting all incoming sources of power, then wait 5 minutes for internal charges to dissipate before servicing the equipment.

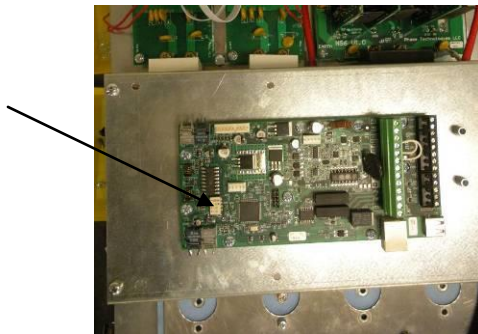

IMPORTANT! The drive must be set to operate in sensorless vector torque control mode in order for wind turbine parameters to function properly. Refer to Table 5-3 and set parameter **SV CONTROL** to the proper value.

The APG Series drive is designed to engage the turbine generator when it is rotating. In order to reduce motoring of the generator at start-up, it is recommended to allow the turbine and generator to free wheel to a speed near that required for power production, then turn the

drive on via a remote switch connected to either of the AUX1 or AUX2 Control Terminals. See Section 3.3, *Control Terminals*, for information on using AUX1 and AUX2.

Manual vs. Auto Mode Operation

Wind turbine control parameters are enabled when either Manual or Auto mode is selected on the keypad. When operating in Manual mode, press the RUN key to start the turbine. **Remember, the turbine must be free-wheeling before the drive is engaged with the generator!** When in Manual mode, the drive will not automatically restart after a stop. The signals from the AUX1 and AUX2 Control Terminals are disabled in Manual mode, as well as the other analog and digital inputs.

It is preferred to operate the drive in Auto mode for wind turbine control. Signals from the Control Terminals are enabled when operating in this mode. RUN and STOP commands are executed by a switch or relay connected to the AUX1 and AUX2 Terminals.

8.2 Upper and Lower Speed Limits

It may be desirable to set upper and lower speed limits on the wind turbine so that it can be shut down in high wind conditions or be shut down when the wind has dropped to a point where power production is no longer feasible.

Controlling the Upper Speed Limit

The parameter ***SPEED LIMIT (RPM)*** sets the upper limit of allowable turbine speed based on RPM of the generator. If the force of the wind on the turbine causes the drive to reach 100% of allowable torque, the drive will allow the speed to increase so as not to exceed 100% torque. The ***SPEED LIMIT (RPM)*** parameter prevents the turbine from exceeding a safe speed. When the generator RPM reaches the limit, the drive will begin a shutdown ramp to stop.

The drive can notify the user that the drive has shut down due to high RPM. This is accomplished by programming any of three digital I/O outputs on Control Terminals J8-1,-2,-3, J8-4,-5 or J8-6,-7. See Table 5-2 *Interface Parameters* for details on programming this signal. This signal is intended to notify the turbine controls to take action. These actions should include applying the turbine brake and opening the remote RUN/STOP signal between either AUX1 or AUX2 Control Terminals.

 **CAUTION:** When the drive receives a STOP or OFF signal it will decelerate to a stop in the time specified by the parameter ***SHUTDOWN RAMP***. If the brake is applied during this ramp time it can potentially interfere with the shutdown ramp.

A STOP signal (opening the connection between the Control Terminals) to either AUX1 or AUX2 will reset the **SPEED LIMIT (RPM)** function. Close the AUX1 or AUX2 Control Terminals to restart the turbine when the wind speed has slowed to a safe level. Be sure to release the brake and allow the turbine to begin turning before starting the drive.

Controlling the Lower Speed Limit

The parameter **SHUTDOWN (RPM)** controls the time the drive is allowed to motor the turbine in low wind conditions. As the wind speed decreases and torque on the generator decreases, generator RPM will decrease to avoid motoring the generator. When speed has reached the lower limit set by **SHUTDOWN (RPM)** the drive will begin to motor the generator to maintain the minimum speed and will continue to motor for the time set by parameter **Tdelay LOW RPM**. If the wind speed has not increased sufficiently to begin generating power before the time set by **Tdelay LOW RPM** expires, the drive will begin a shutdown ramp to stop in the time set by parameter **SHUTDOWN RAMP**.

The drive can notify the user that the drive has shut down due to high RPM. This is accomplished by programming any of three digital I/O outputs on Control Terminals J8-1,-2,-3, J8-4,-5 or J8-6,-7. See Table 5-2 *Interface Parameters* for details on programming this signal. This signal is intended to notify the turbine controls to take action. These actions should include applying the turbine brake and opening the remote RUN/STOP signal between either AUX1 or AUX2 Control Terminals.

A STOP signal (opening the connection between the Control Terminals) to either AUX1 or AUX2 will reset the **SPEED LIMIT (RPM)** function. Close the AUX1 or AUX2 Control Terminals to restart the turbine when the wind speed has increased to a level adequate to produce power. Be sure to release the brake and allow the turbine to begin turning before starting the drive.

8.3 Tracking Peak Power with Variable Speed Operation

When connected directly to the utility grid, an induction generator runs at near-synchronous speed, determined by the frequency of the AC power on the grid. If the turbine is controlled by a regenerative drive without power tracking capability, it will simply run at the speed commanded by the inverter module of the drive, regardless of power production efficiency. The same is true of permanent magnet (PM) generators.

When operating in wind turbine mode, an APG Series drive is capable of searching for peak power production by varying the speed of the turbine in response to changes in power production. Through control by the PWM inverter on the load side of the APG Series drive, the turbine speed can be varied in response to fluctuating wind, substantially increasing the power production. The parameter **MaxPwr Search** enables the drive to search for peak power production by varying the speed. This method of tracking peak power production

relies on data from the turbine power curve that is entered in the parameters **OPTIMIZE PWR** and **OPTIMIZE SPEED**. A total of five points on the curve can be entered. See Table 5-6, *Wind Turbine Parameters*, for details on setting these parameters. For example, in a power curve represented by Figure 8-2, the first point would have an **OPTIMIZE PWR** value of 16 and an **OPTIMIZE SPEED** value of 300.

Figure 8-2 Power Optimization Curve

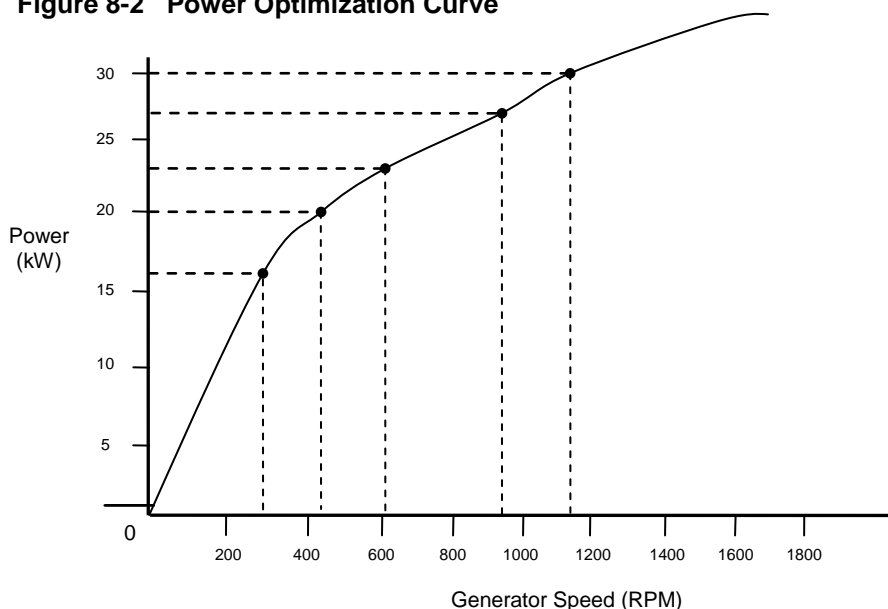

Operating with **MaxPwr Search Disabled**

When this parameter is set to a value of zero, the feature is disabled and the turbine will operate at a maximum speed determined by the parameter **MAX FREQUENCY** as long as power is produced at that speed. If no power is being produced at a given speed, the speed will be reduced to avoid motoring.

For example, if the **MAX FREQUENCY** is set at 60 Hz and the drive engages the turbine with the wind turning it at 50 Hz, the drive will allow the wind to push the turbine speed as high as 60 Hz so long as it is producing power. Any time the turbine begins to motor, the drive will reduce the speed just enough to begin generating power. Rather than search a range of speed to find the highest level of power production, the drive will operate as close to MAX FREQUENCY as possible while producing power and avoiding motoring.

If the speed is reduced to the lower speed limit as determined by the parameter **SHUTDOWN (RPM)**, the drive will shut down in a manner consistent with the values set for this and related parameters. See the paragraph on *Controlling the Lower Speed Limit* in this Section for details.

Operating with *MaxPwr Search* Enabled

When this parameter is set to a value of 1, the feature is enabled and the drive will search for peak power by varying turbine speed in the direction of greater power. The output power of the turbine and speed are sampled at regular intervals of time. If the wind speed is steady, the difference in the power samples will be small and speed will not be changed. If there is a jump in wind speed the change in power will be large and positive, and a positive change in speed will result. Conversely, if the wind velocity declines significantly, the change in power will be large and negative, and will result in a negative change in speed. Choose up to 5 points on the turbine power curve and enter a corresponding value of **OPTIMIZE PWR** and **OPTIMIZE SPEED** for each point.

8.4 Speed Bands

For any given wind turbine, there may be a speed or speeds at which it is not desirable to operate the turbine. This could be due to vibration at that speed, or other undesirable physical forces on the turbine.

An APG Series drive features three speed bands, each with a high and low limit that can be set to avoid operating in that speed range. The parameters, **BAND 1 (LOW RPM)**, **BAND 1 (HIGH RPM)**, etc. are used to set these speed bands.

If BAND 1 is set with a LOW RPM value of 900 and a HIGH RPM value of 1000 the drive will avoid operating in this band by accelerating or decelerating through the band, depending on the direction of speed change, as it approaches the band. The rate of acceleration or deceleration through the band is limited by motor torque. The change in speed will occur in a manner that limits time in the band without exceeding 100% of rated motor torque.

This section provides information on status indicators that display information about the operating parameters of the system and troubleshooting tips for potential system problems.

 **WARNING!** In some instances, the unit will shut down, then automatically restart when conditions allow. Always disconnect input power from the unit and wait for internal electrical charges to dissipate before performing service on the unit or its connected loads.

 **WARNING:** Risk of electric shock. De-energize the unit by disconnecting all incoming sources of power, then wait 5 minutes for internal charges to dissipate before servicing the equipment.

 **HIGH VOLTAGE:** This equipment is connected to line voltages that can create a potentially hazardous situation. Electric shock could result in serious injury or death. This device should be installed and serviced only by trained, licensed and qualified personnel. Follow instructions carefully and observe all warnings.

Always check the LCD display for fault codes if the drive or its load is not operating. Disconnecting the input power will clear any fault code indication, possibly losing valuable information for troubleshooting.

9.1 Status Indicators and Fault Codes

Fault codes are indicated on the LCD display in 2-row, 32-character text messages. See Table 9-1 for a list of fault codes.

An auto restart fault can be cleared by either cycling the input power OFF/ON, or by simultaneously pushing the up-arrow and down-arrow keys. Either of these actions resets the Fault Counter for ALL faults to zero. Remember that clearing the Fault Counter does not clear the Fault Log. The Fault Log is cleared through the **CLEAR MEMORY** parameter.

 **WARNING:** Certain faults do not allow an auto restart. These faults generally indicate the possibility of damage to the drive and/or the load, or indicate the possibility of a dangerous condition. When a fault occurs, refer to Table 9-1, *Fault Codes*, to determine if the fault allows an auto restart. The number 1 in the notes column indicates that auto restart is not allowed. When this type fault occurs, contact the factory for assistance before restarting. These faults can be cleared only by cycling input power OFF/ON. When cycling the power, wait for the display to go dark before turning the input power back to ON. The

controls get their power from the DC bus and it may take several minutes for the bus to discharge.

⚠ WARNING: Unit may restart automatically without warning after a fault when operating conditions permit. Make certain input power is disconnected before servicing the unit or its connected loads.

Clearing a Fault

A fault that allows auto restart can be cleared by either cycling the input power OFF/ON or by simultaneously pushing the up-arrow and down-arrow keys. If the unit is programmed to automatically restart after a particular fault, the display indicates that the unit will restart and will count down the seconds remaining to restart on the display.

For faults that allow an automatic restart, the default number of restarts after a fault is zero. If the end user desires the unit to automatically restart after a fault, the number of restarts allowed and the time between fault and restart must be programmed in the **CHANGE PARAMETER VALUES > AUTO RESET PARAMETERS** for that fault.

The **ENABLE RESTART** parameter must also be set to enable restarts in order for the drive to restart automatically after a fault. This parameter also enables to drive to initialize in AUTO mode when the input power has been cycled OFF/ON and the drive is energized. Navigate to this parameter via **CHANGE PARAMETER VALUES > OPERATING PARAMETERS > ENABLE RESTART**. See Table 5-1 for values in setting the parameter.

Table 9-1 Fault Codes

TEXT MESSAGE	DESCRIPTION / COMMENTS	NOTES
OUTPUT FAULT	Check for short circuit on output lines and load. Contact factory	1
INPUT FAULT	Abnormally high current on line-side module. Possible internal fault. Contact factory.	1
OVER TEMPERATURE	Internal temperature of the drive exceeded safe limits. Check fans and ventilation openings for obstruction. Reduce ambient temperature.	2
BUS OVERVOLTAGE	Sudden and severe regenerative power under high line voltage conditions may result in bus overvoltage. Check line voltage or consider increasing ramp up and ramp down times.	2
UNDER CURRENT	Motor current has fallen below the value set in UNDERCURRENT LIM under OPERATING PARAMETERS menu. Commonly used to detect dry well condition.	P, 2
SINGLE PHASING	Current unbalance greater than 80%. Check motor load, terminals and leads.	2

Troubleshooting

TEXT MESSAGE	DESCRIPTION / COMMENTS	NOTES
POSSIBLE SHORT	Possible short on output or internal fault. Check output lines and load for short circuit, or contact factory.	1
LOW VOLTAGE IN	Input voltage has fallen below a level for safe operation of the drive.	2
OUTPUT OVERLOAD	Indicates a large and sudden overcurrent event on the output module. Check the motor circuit for faults. Sudden changes in the load may also have occurred such as the closing of a relay that results in an across-the-line start of a motor. Never install relays in the motor circuit.	1
CURRENT BALANCE	Motor current unbalance has exceeded the limit set in CURRENT UNBALANC under CHANGE PARAMETER VALUES menu. Check motor load for normal operation, or increase current unbalance limit.	P, 2
TEMP SENSE FAULT	Solid state temperature sensor on the heat sink has failed or its cable is disconnected. Contact factory.	1
HIGH VOLTAGE IN	Input voltage has exceeded a level for safe operation. Reduce input voltage. General purpose buck/boost transformers are compatible with AP Series drives.	2
Class 10 OVERLOAD	Output current has exceeded the value set for OVERCURRENT LIMIT in OPERATING PARAMETERS menu. Check status of motor load. If output current limit is increased, make sure it is within the limit of the motor nameplate. Automatic restarts are set by RESTART DELAY 1 and RESTARTS CUR OVL in the AUTO RESTART PARAMETERS menu.	P, 2
BUS NOT CHARGING	Pre-charging routine failed to charge DC bus to proper level. Possible bus cap failure or charging resistor failure.	1
OVERCURRENT IN	Current on line-side module exceeded rated current. Check for faults or overload in the motor circuit. Low input line voltage may result input module overload. De-rate drive linearly as input voltage decreases from specified voltage. Automatic restarts are set by RESTART DELAY 1 and RESTARTS CUR OVL in the AUTO RESTART PARAMETERS menu.	2
DRY WELL	Real power in kW consumed by the motor load has fallen below the limit set in MINIMUM POWER under CHANGE PARAMETER VALUES menu. Commonly used to detect dry well condition.	P, 2
INPUT COMM	Communication has been lost between master controller and input module. Check optical cable from MC printed circuit board to input control I/O board.	1
OUTPUT COMM	Communication has been lost between master controller and output module. Check optical cable from MC printed circuit board to output control I/O board.	1

Troubleshooting

TEXT MESSAGE	DESCRIPTION / COMMENTS	NOTES
FAILED CONTACTOR	Indicates that the contactor in the pre-charging circuit has failed	1
BUS OV, INPUT BD	Sudden and severe regenerative power under high line voltage conditions may result in bus overvoltage. Check line voltage or consider increasing ramp up and ramp down times.	1
BUS OV, OUTPUT BD	Sudden and severe regenerative power under high line voltage conditions may result in bus overvoltage. Check line voltage or consider increasing ramp up and ramp down times.	1
BRAKE APPLIED	The initiation of braking resistor has been detected by the Brake Sense circuit which shuts the drive down in a protection mode. Check the utility grid connection and for any source of severe regenerative power.	1
AUX3 LATCH FAULT	When set in System Configuration 10, AUX3 is a latching relay. When the contacts on AUX3 open, the digital input will remain in that state until the fault is cleared.	3
GROUND FAULT	A fault between an output line and earth has been detected. Immediately disconnect input power and check output lines with a megger to verify a fault. Nuisance trip is a possibility. Sensitivity of fault detection can be adjusted by the Operating Parameter GND FAULT DETECT . See Table 5-1 for details.	1
BUS V UNBALANCE	The two voltages on the DC bus, Vpos-Com and Vneg-Com, are more than 10% unbalanced. Usually caused by failure of one or more electrolytic capacitors on the bus. Contact factory.	1

P = Fault may be related to an adjustable parameter. Always check the value of the parameter to eliminate nuisance tripping.

1 = Drive has shut down due to a potentially dangerous condition. Drive will remain OFF until input power is cycled OFF/ON. Use caution if the drive is restarted.

2 =  **WARNING:** Auto restart allowed for this fault. Motor may restart automatically without warning after a fault when operating conditions permit. Make certain input power is disconnected before servicing the unit or its connected loads.

3 = Latching fault. Fault can be cleared by cycling power OFF/ON or by simultaneously pushing the up-arrow and down-arrow keys.

Fault Log

The Fault Log records the number of times a particular fault has occurred. To access the Fault Log, press the MENU key until the Main Menu item, FALUT LOG, appears. Press ENTER key to access the list of faults. The Fault Log will continue to log the number of faults that have occurred until it is reset through the Main Menu item **CLEAR MEMORY**. Navigate through the Main Menu on the keypad to **CLEAR MEMORY**, press ENTER, then use the arrow keys to select **CLEAR FAULTS**, then reset the Fault Log by pressing ENTER. Refer to Section 4.2.3, *Fault Log*, for details. The Fault Log is not to be confused with the Fault Counter. The Fault Counter is associated with the automatic restart function and is reset whenever the input power is cycled OFF/ON or by simultaneously pushing the up-arrow and down-arrow keys..

Table 9-2 Troubleshooting

PROBLEM	POTENTIAL CAUSE	SOLUTION
Motor not running	Is a fault code indicated?	Based on the fault code, resolve any factors that are likely causing the fault. Clear the fault by double-clicking the OFF key on the keypad or by cycling input power OFF/ON.
	Are the remote switches AUX1, -2, -3, -4 closed?	Check the status of the switches or jumpers connected to AUX1, -2, -3, -4 on the Control Terminals. The LCD display indicates the status of AUX terminals in the default display mode. All AUX terminals must be closed for the motor to run in AUTO mode.
	Are the signals to the Control Terminals corrupted?	Shielded cable is required for AUX terminal switch leads longer than 20 ft. Regular wire will induce capacitance in the line and corrupt control signals. Shielded cable is recommended for all Control signal cables.
	Are the signals to the analog inputs on the Control Terminals correct?	Verify 0-5VDC or 4-20mA signals to Control Terminals. Analog signal levels can be viewed by navigating to the keypad Main Menu item READ MEASURED VALUES .
	Is the keypad in MAN or OFF mode?	The keypad will override signals on the Control Terminals when OFF or MAN is selected. Keypad must be in AUTO mode for external control signals to control the motor.
	Is the maximum frequency set at 0 Hz?	Check the maximum frequency by using the keypad to navigate MAIN MENU>CHANGE PARAMETER VALUES>OPERATING PARAMETERS>MAX FREQUENCY .
	Are the input terminals L1 and L2 energized?	LED D19 on the Master Control printed wiring board should be on. If no LEDs are lit on the PWB, check the main input fuses or breaker. Check the secondary circuit fuses. See Figure 9-1, <i>Fuse Location</i>
Motor is turning the wrong direction	Phase sequence on output terminals U/T1, V/T2, W/T3 is out of order	Swap any two of the three motor leads on the output terminals.

9.2 Routine Inspection and Maintenance

The unit should be inspected and cleaned at least annually, or more frequently if it is located in an excessively warm or dusty environment.

Power terminals: Inspect for loose connections and tighten to specifications in Table 3-2, Field Wiring Power Terminal Specifications.

Capacitors: Check for leakage or deformation.

Overall: Perform a visual inspection checking for things such as discolored wires or terminals, evidence of arcing, loose mounting screws, physical damage to the enclosure, etc.

Fans and heatsinks: Excessive dust buildup on the heatsink and cooling fan impellers may lead to overheating. Lightly brush and vacuum clean.

Instructions for fan replacement: Contact Customer Service for assistance in replacing the cooling fan in the event it should fail. Use only fans approved by Phase Technologies. Unapproved fans may not be able to move enough air to properly cool the unit, leading to component damage.

Fuses: There are several field replaceable fuses in the drive. Each fuse is assigned a designator to help identify the fuse. Replacement fuses are available from the factory by contacting Customer Service at 605-343-7934. Refer to Table 7-3 for fuse ratings.

Fuse Designator	Fuse Rating	Comments
F1	1000 VDC, 2 A	Primary of control transformer
F9	24 V minimum, 6 A fast acting	Cooling fan (only on models with 2 fans)
F11	250 V, 30 A	Only for 240 V input models. Pre-charging circuit
F11	500 V, 30 A	Only for 480 V input models. Pre-charging circuit

Figure 9-1 Fuse Location

Fuses F1, F9, are located on the Power Supply printed circuit board. Remove the front cover to gain access. In 60 and 75 HP models (not pictured) the Power Supply printed circuit board is located near the top of the enclosure.

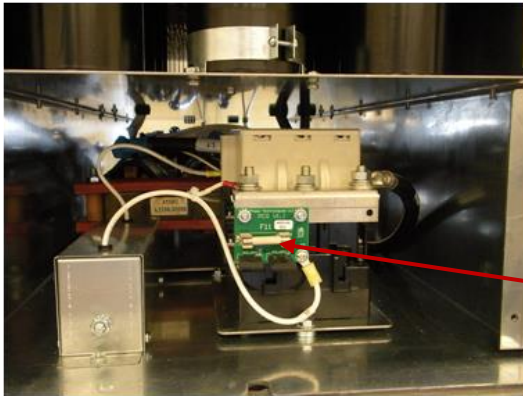
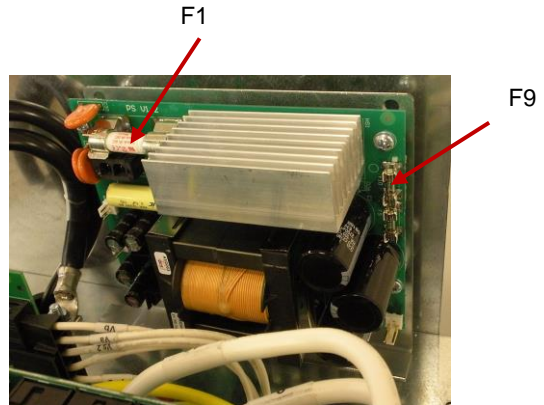

Fuse F11 is located in the bottom of the drive on a small printed circuit board attached to the contactor in the pre-charging circuit. Remove the bottom cover to gain access.

F11

APG Series drives are capable of serial communication with a computer or PLC using MODBUS RTU, RS485 4-wire or 2-wire protocol. Parameters that control the settings for MODBUS serial communication are found in the User Interface parameters menu and can be found in Table 5-2, *Interface Parameters*.

Typically, a host computer controls a drive or multiple drives on a MODBUS network as illustrated in Figure 10-1. Each drive must have a unique address on the network, from 1 to 1,000.

Figure 10-1 MODBUS Network

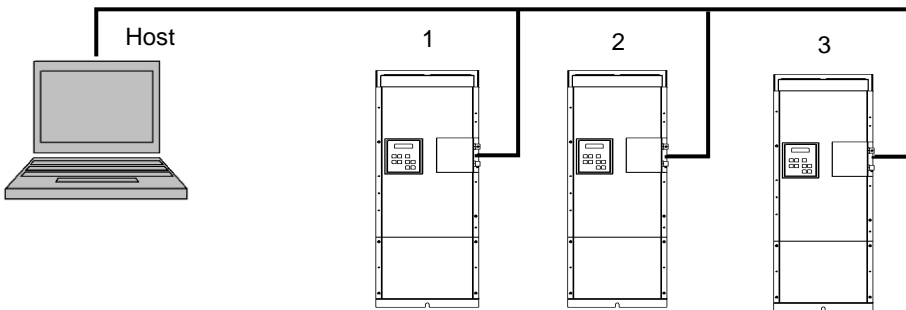

When connected to a MODBUS network the drive can be controlled by either the keypad or by MODBUS commands. If it is desirable to have only MODBUS control, the keypad can be disabled by disconnecting the keypad cable with RJ45 connector on the MC printed circuit board. Refer to Figure 10-2 for the location of the keypad RJ45 terminal.

10.1 Connecting a MODBUS Network to the Drive

The drive MODBUS communication uses RS485 differential transceiver. Network wires are connected to the Control Terminals located on removable terminal blocks mounted on the Master Control printed circuit board. See Figure 3-3, *Control Terminal Panel*, in Section 3 for instructions on accessing these terminals. MODBUS terminals Z, Y, B, A and C are located on Terminal Block J7.

For a complete list of MODBUS coils and registers, contact the manufacturer or download the document from the website at www.phasetechnologies.com.

Figure 10-2 MC Printed Circuit Board

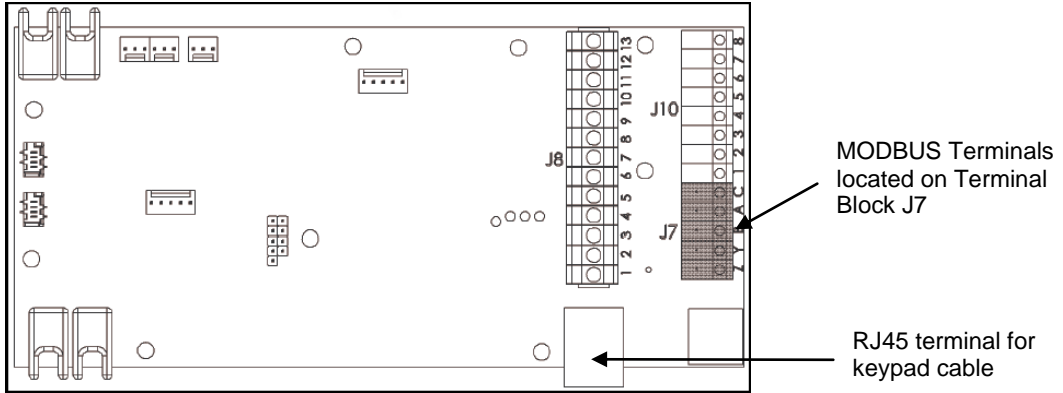

RS485, 2-Wire Connection

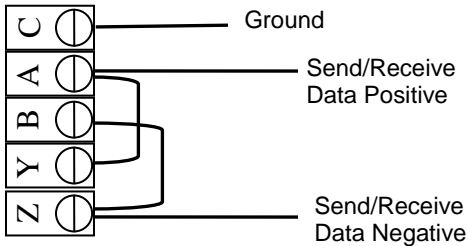

2-Wire Connection Procedure

1. Connect terminal Y to A with a jumper wire.
2. Terminal Y-A = Send/Receive Data Positive.
3. Connect terminal B to Z with a jumper wire.
4. Terminal B-Z = Send/Receive Data Positive.
5. Connect ground wire to terminal C

RS485, 4-Wire Connection

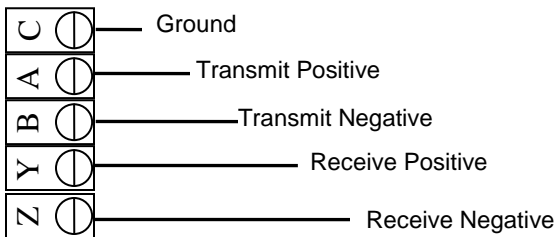

10.2 Windows Compatible Software

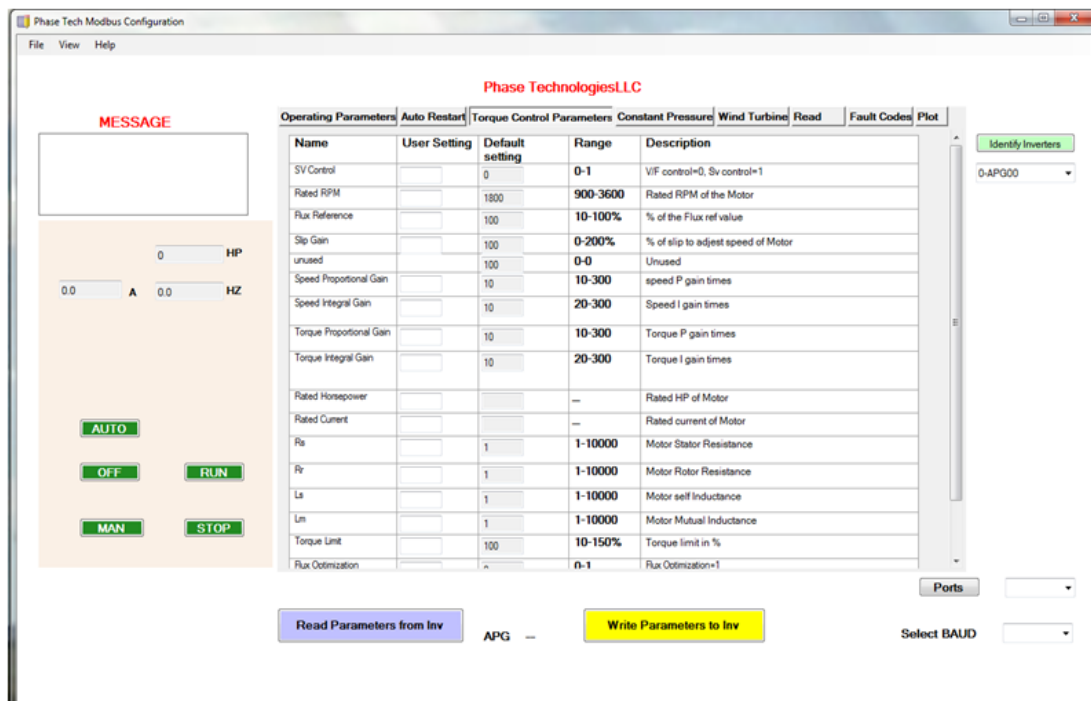

Windows compatible software is available that allows the drive to be operated from a personal computer via the MODBUS terminals. An Ethernet connection will allow operation from a remote location.

The application can be downloaded from the manufacturer's web site at www.phasetechnologies.com. Contact the manufacturer for assistance in choosing the hardware necessary for MODBUS or Ethernet communication through the Windows Compatible Software.

Limited Warranty

LIMITED WARRANTY

Phase Technologies equipment is warranted against defects in material and workmanship for a period of one year. This warranty covers both parts and labor for one year from the date of purchase by the original owner. Phase Technologies will repair or replace (at our option), at no charge, any part(s) found to be faulty during the warranty period specified. The warranty repairs must be performed by/at a Phase Technologies Authorized Service Center or at Phase Technologies LLC, Rapid City, SD.

Obligations of the Original Owner

1. The original Bill of Sale must be presented in order to obtain "in-warranty" service.
2. Transportation to Phase Technologies or an Authorized Service Center is the responsibility of the original purchaser. Return transportation is provided by Phase Technologies.
3. Installations must comply with all national and local electrical codes.

Exclusions of the Warranty

This warranty does not cover any of the following: accident, misuse, fire, flood, and other acts of God, nor any contingencies beyond the control of Phase Technologies, LLC, including water damage, incorrect line voltage, improper installation, missing or altered serial numbers, and service performed by an unauthorized facility. Phase Technologies' liability for any damages caused in association with the use of Phase Technologies' equipment shall be limited to the repair or replacement only of the Phase Technologies' equipment. No person, agent, distributor, dealer, or company is authorized to modify, alter, or change the design of this merchandise without express written approval of Phase Technologies, LLC.

**INSTALLATIONS MUST COMPLY WITH ALL NATIONAL AND LOCAL ELECTRICAL
CODE REQUIREMENTS.**

Notes
